

DEVELOPMENT OF A MECHANICAL FEEDING UNIT SUITABLE FOR ONION SEEDLINGS

EL-Sheikha M. A*; **H. E. EL-Morsy*;** **S. E. Badr**** and **W. M. Z EL-Balkimy****

* Dept. of Agric. Eng. - Faculty of Agric., Mansoura University, Egypt.

** Institute of Agric. Eng., Center of Agric. Researches, Egypt.

ABSTRACT

Experiments were carried out using a developed mechanical feeding unit using feeding belt with cells on its out surface to study the effect of linear speed of feeding belt, speed ratio between conveyor belt and feeding belt, seedling bulb diameters and cell width of feeding belt on onion seedlings properties (seedling feeding rate, inclined seedlings percentage, damaged seedlings percentage and average seedlings spacing) and power consumed. The best results of seedlings feeding rate were 153 seedlings/min, inclined seedlings percentage 5.69 %, damaged seedlings percentage 3 %, average seedlings spacing (11-12 cm) and useful power consumed 0.0994 kW. This data were obtained at operating the developed mechanical feeding unit at linear speed of feeding belt of 0.347 m/s, relative linear speed of 1.33, feeding belt cell width of 3 cm and by using onion seedlings with diameter of ($5 < 10$ mm).

INTRODUCTION

The most important and famous of vegetable crops that has been planted in Egypt for centuries with the traditional method of manual transplanting is onion crop which have a marketing and economic importance as the first rank among transplanted crops. Area annually planted with onion is more than 200,000 feddans (C.A.P.M.A.S.2013). Onion, (*Allium cepa* L.) is one of the main important and oldest vegetable crops grown in Egypt. The Egyptian onion is famous all over the world for its superior quality and early appearance in European markets. Onion although primarily is grown for food, it is also used as traditional medicine. The vegetable transplanter available in Egypt is a semi-automatic transplanter which fed with seedlings manually by one worker at least for every transplanter unit of the machine. This transplanter has a limited operating speed due to the need for manual feeding of one seedling cell after another and is not suitable for continuous operation over a long period of time. The fully automatic allows for high-speed operation and labor-saving, because seedlings fed automatically by the machine itself can be planted. However, the fully automatic transplanters that have been developed so far can use only limited types of seedling trays with prepared seedlings suitable for every type of trays. This led us to try to develop a simple mechanical feeding unit use the available traditional seedlings that named with (bare-root seedlings) such as onion. Several studies were conducted in this field as follows:

Sakaue (1996) developed and tested four prototypes of transplanting machines to automate seedlings feeding. These prototypes were as follows:

- (1) Automatic seedling feeding device using rotating pickup arm. Work efficiency was 650 plants/h which is quite low for practical application.
- (2) Automatic seedling feeding device using a rank of pistons to push out root blocks from cell tray and a traverse conveyor to transport seedlings toward the rotating part to insert them into soil. Work efficiency was 2250 plant/h which is relatively high. However, the design conditions of compact transplanter size.
- (3) Automatic transplanter using pistons, traverse conveyor and rotating insert cups. Work efficiency was more than 2400 plants/h.
- (4) Automatic transplanter using flat belt conveyor, traverse conveyor and rotating insert cups. Work efficiency was more than 2100 plants/h.

Lin *et al.* (2000) modified a self-propelled vegetable seedling transplanter. Modifications laid emphasis on the reconstruction of the power transmission system and the cam for feeding vegetable seedlings. A hydraulic system was applied to substitute the conventional pulleys and sprockets. Meanwhile, the cam profile was evaluated and redesigned to have the needle, which transports seedlings from trays to planting device, perform smoothly. Experimental results showed that plant spacing, which is 45.0 cm theoretically, was between 45.2 to 46.7 cm in the laboratory and 44.5 cm in average in the field, while engine speed was between 600 and 1800 rpm. The modified cam improved the function of the needle, and increased the success ratio of transplantation to 90% or more from 44%. Kim *et al* (2001) developed an automatic transplanter for planting Chinese cabbage. It is mainly composed of a pick-up system, and a feeding system for cabbage seedlings. The criteria of designing plug tray were proposed to use both 128 cell and 200 cell plug trays for feeding system. The accuracy of the pick-up system was evaluated in the laboratory and the rate of successful picking was 99.5% for 20 day-old cabbage seedlings. The pick-up system correctly separated the cabbage seedlings from the tray one by one and planted it in to the soil with a maximum failure of 3.5%. Choi *et al.* (2002) developed and evaluated in laboratory a new seedling pick-up device for vegetable transplanters. The pick-up device extracts seedlings from a 200-cell tray and transfers them to a position from which they can be transplanted into the soil. The device consists of a path generator, pick-up pins, and a pin driver. The path generator is a five-bar mechanism comprised of a fixed slot, a driving link, a driven link, a connecting link, and a slider. The slider is constrained to move along the driven link and a fixed slot of combined straight-line and circular paths. The connecting link joins the driving link and the slider. When the slider moves along the straight-line path of the slot, it takes a seedling from a cell. When it moves along the circular path, it transfers the seedling to the transplanting hopper. The slider is an assemblage of pick-up pins and a pin driver, which are integral parts of the device. The device extracted 30 seedlings per minute with a success ratio of 97% using 23-day-old seedlings. Hu and Yin (2011) designed a deformed sliding needle-type pick-up device for plug seedlings to develop a semi-automatic transplanter. An orthogonal experiment on the designed device was used to study the picking success rate, the influencing factors and the best working conditions. The factors selected for this experiment were the vegetable plug seedlings' own physical

characteristics, seedling plug moisture content, the angle and the velocity of picking plug seedlings and the number of gripper needles. The experimental results showed that, the average picking success rate was 83.61%, the number of needles and seedling age were two major factors which might affect the success rate of picking operation and the angles was next. The highest picking success rate was obtained as 25-day-old seedling, 4 gripper needles, and pick plug seedlings with 36 degrees angles. Kumar and Raheman (2012) developed an automatic feeding mechanism consisting of a timing shaft, an actuating device and a clutch for feeding paper pot seedlings from a horizontal slat type chain conveyor to a horizontal pusher type chain conveyor of a vegetable transplanter. The slat type chain conveyor carried the pot seedlings in upright orientation in the form of a rectangular array with each linear array of pot seedlings on a slat. The pusher type chain conveyor received a linear array of pot seedlings and delivered them to the seedling drop tube. Feeding of each linear array of pot seedlings to the pusher type conveyor at appropriate times was done using an automatic feeding mechanism. The laboratory evaluation indicated that, the feeding rate of 33 to 50 pot seedlings per minute can be achieved with single set of conveyors. The feeding mechanism also worked effectively under actual field conditions with 98% to 99% of all the pot seedlings, which were properly separated and fed for planting when the linear speed of the vegetable transplanter was 0.9 m/s. Li-gang and Gao-hong (2012) analyzed and designed a seedling-delivering device on an automatic transplanter. A detailed design of the structures is presented, including the structural parameters of the automatic seedling-delivering device. A prototype of the test bed for this device is developed. The result indicates that, the design is reasonable. The maximum test speed of feeding the seedlings can reach 200 individual plants per minute, which satisfies the working requirements of high-speed seedling delivery for automatic transplanters.

The main objectives of this study were as follows:

- Development a simple model of mechanical feeding unit suitable for bare-root seedlings to be installed on the semi-automatic transplanter.
- Testing and evaluation of the suggested mechanical feeding unit under operational parameters in lab considered with main properties of disposed seedlings.

MATERIALS AND METHODS

Developed seedlings feeding unit:

The main parts of the mechanical feeding unit shown in Figure (1) and Table (1) were as follows:

- **Main frame:** It consists of two pieces, front and rear made of square steel rods welded together gently.
- **Seedlings hopper:** The rectangular seedlings hopper of 600 × 400 × 200 mm length, width and height respectively made of nickel chrome sheets (1.5 mm thickness) without bottom was installed upon the rear frame. The seedlings placed in the hopper horizontally. There were three vertical gates

in this hopper to regulate the seedlings flow. The height of these gates was adjusted on a descending height begins from 4 then 3 and 2 cm.

- **Hopper belt:** A flat belt of 1680 × 300 × 1 mm length, width and thickness respectively made of cotton fibers. Wooden beams of 280 × 20 × 15 mm length, width and height respectively was fitted on its out surface at distances of 20, 30 and 40 mm to make what called cells to fill them with seedlings.
- **Conveyor belt:** A flat belt of 1380 × 300 × 1 mm length, width and thickness respectively made of cotton fibers was fixed on the front frame. This belt was responsible for adjusting the seedlings spacing according to each crop characteristics by changing its linear speed.

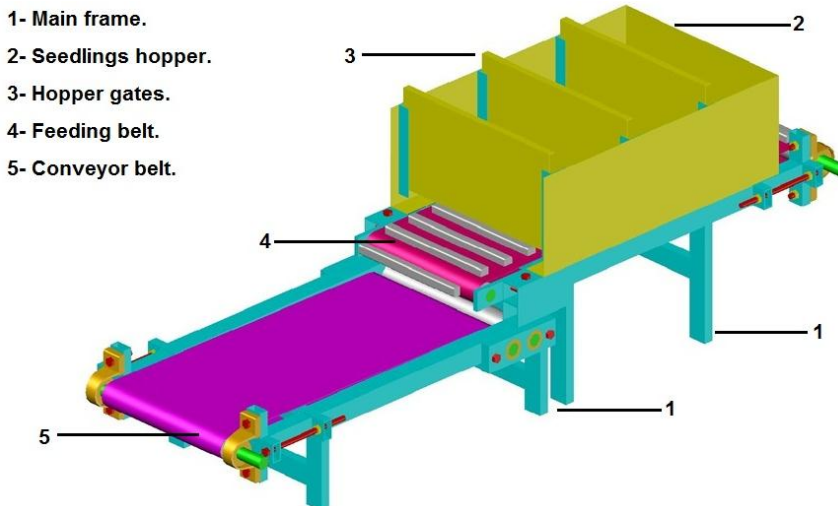

Figure (1): Schematic Isometric of the mechanical feeding unit.

Table (1): Specifications of the mechanical feeding unit:

Overall dimensions & Weight:		Seedlings hopper:			
Length	mm	1630	Material	nickel chrome	
Width	mm	510	Shape	Rectangular	
Height	mm	460	Length	mm	600
Weight	Kg	75	Width	mm	400
			Height	mm	200
Feeding belt:		Conveyor belt:			
Material	cotton fibers	Material	cotton fibers		
Shape	Flat	Shape	Flat		
Length	mm	1680	Length	mm	1380
Width	mm	300	Width	mm	300
Thickness	mm	1	Thickness	mm	1
Extensions installed	Wooden beams				

Used crop:

Random (bare-root) onion seedlings were used in this study to evaluate the development model of mechanical feeding unit.

Scope of variables and treatments:

The experimental studies were executed to determine the effect of:

Linear speed of feeding belt (V):

Four linear speeds obtained by a lathe as a power supply were used to run the prototype of mechanical feeding unit during test operation.

Variable levels were as follows:

$$V_1 = 0.208 \text{ m / sec} \quad , \quad V_2 = 0.277 \text{ m / sec}$$

$$V_3 = 0.347 \text{ m / sec} \quad \text{and} \quad V_4 = 0.416 \text{ m / sec}$$

Speed ratio between conveyor belt and feeding belt (R_s):

Four speed ratios between conveyor belt and feeding belt were used in this study by a means of several pinions.

$$R_s = \frac{L1}{L2} \dots\dots\dots (1)$$

where:

R_s : Speed ratio between conveyor belt and feeding belt.

L1 : Linear speed of conveyor belt, m/s.

L2 : Linear speed of feeding belt, m/s.

Variable levels were as follows:

$$R_{s1} = 1 \quad , \quad R_{s2} = 1.33 \quad , \quad R_{s3} = 2 \quad \text{and} \quad R_{s4} = 2.63$$

Seedlings bulb diameter (D):

Three seedlings bulb diameters were used in this study as a parameter of seedlings age.

Variable levels were as follows:

$$D_1 = \geq 5 \text{ mm} \quad , \quad D_2 = > 5 < 10 \text{ mm} \quad \text{and} \quad D_3 = \geq 10 \text{ mm} .$$

Cell width (C):

Three cell widths were used in this study by using wooden beams fitted on the out surface of feeding belt at different spaces.

Variable levels were as follows:

$$C_1 = 2 \text{ cm} \quad , \quad C_2 = 3 \text{ cm} \quad \text{and} \quad C_3 = 4 \text{ cm} .$$

Measurements:

During lab experiments were carried out in the workshop, onion seedlings disposed from the prototype were examined to determine the following:

Seedlings feeding rate (Q):

Seedlings disposed from the prototype at the end of conveyor belt in every experiment were collected and counted to determine the feeding rate of the machine in one minute.

Inclined seedlings percentage (I_p):

Inclined seedlings on the conveyor belt which were than 30° with the perpendicular line on direction of seedlings flow according to (Dhaliwal *et al*, 2011) were counted, and inclined seedlings percentage (I_p) was given as follows:

$$I_p = \frac{I}{Q} \times 100 \dots\dots\dots (2).$$

Where:

- I_p : Inclined seedlings percentage.
- I : Count of inclined seedlings disposed from the machine.
- Q : Total seedlings disposed from the machine in one minute.

Damaged Seedlings percentage (S_d):

Damaged seedlings disposed from the machine were examined virtually by the naked eye to look for damaged in the bulb of onion seedlings then, minus with the average estimated damaged percentage in seedlings before exposed to the mechanical feeding unit which was found about (1 %). It was given as follows:

$$S_d = \left[\frac{M}{Q} \times 100 \right] - S_{db} \dots\dots\dots (3).$$

Where:

- S_d : Damaged seedlings percentage.
- M : Count of damaged seedlings disposed from the machine.
- Q : Total seedlings disposed from the machine in one minute.
- S_{db} : Average seedlings estimated damaged percentage before exposed to the mechanical feeding unit.

Average seedlings spacing (A_s):

For a length of one meter of the conveyor belt, distances between seedlings on its out surface were measured by a tape measure, and average seedlings spacing was determined as follows :

$$A_s = \frac{100}{(N-1)} \dots\dots\dots (4).$$

Where:

- A_s : Average seedlings distance.
- N : Number of seedlings in one meter of conveyor belt.

5- Determination of power required (P):

The consumed power (kW) was calculated from the knowledge of line current strength (I) and potential difference values (V) using the following formula: (Ibrahim, 1982).

$$P = \frac{\sqrt{3} I.V.\eta.Cos\theta}{1000} \dots\dots\dots (5).$$

Where:

- P : Power required.
- I : Line current strength in amperes.
- V : Potential difference (Voltage) being equal to 380 V.
- $Cos \theta$: Power factor (being equal to 0.84).
- $\sqrt{3}$: Coefficient current three phase (being equal to 1.73).
- η : Mechanical efficiency assumed (90 %).

• Experimental Procedure:

Mechanical feeding unit has been implemented in a workshop in the village of Mit Ali in Dakahlia Governorate, and all the tests and experiments were done in the same place using a lathe as a power supply to run the

prototype during test operation. At the beginning of experiments, a worker feeds a group of onion bare-root seedlings in the end of the seedlings hopper in horizontal orientation, and help to minimize the overlapping between seedlings in the hopper during tests. During carrying out the experiments, the digital tachometer was used for measuring the rotating speed of the lathe, feeding belt and conveyor belt. Also, electricity power consumed was determined by using AVO meter at all treatments. In addition time consumed during tests was recorded by means of a stopwatch. A measure tape was used to estimate the average seedlings spacing at all experiments. Finally, all seedlings disposed from the prototype at all experiments were examined to estimate the seedlings damage during tests.

RESULTS AND DISCUSSION

1- Seedlings feeding rate:

As shown in Figure (2), it is clear that, increasing the linear speed of feeding belt tends to increase seedlings feeding rate for all cell widths at different seedling bulb diameters until reach speed of 0.347 m/s, and then tends to decrease seedlings feeding rate due to inability to fill the belt cells with enough seedlings at high speeds. From the data, it was noticed that, by increasing the linear speed from 0.208 to 0.347 m/s, the seedlings feeding rate increased from 83 to 144 and from 90 to 152 seedling/min at speed ratio of 1, seedlings bulb diameter of (≤ 5 and ≥ 10 mm) and cell width of 2 and 4 cm respectively.

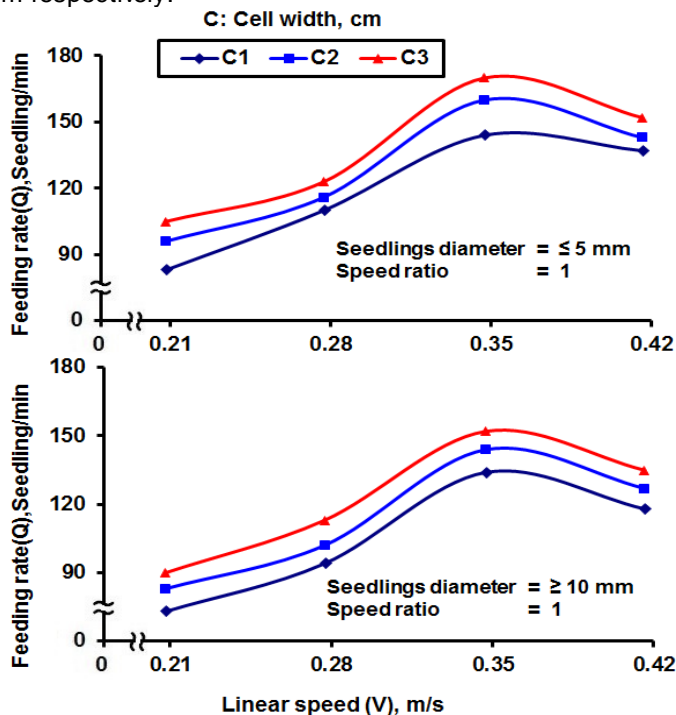

Figure (2): Effect of linear speed and cell width on seedlings feeding rate at different Seedling diameters.

On the other hand, the seedlings feeding rate decreased from 144 to 137 and from 152 to 135 seedling /min by increasing linear speed from 0.347 to 0.416 m/s at the same parameter levels mentioned above.

Also, at all linear speeds and seedling bulb diameters, increasing cell width of feeding belt tends to increase seedlings feeding rate due to increasing in spaces or pockets which hold more seedlings on the feeding belt surface. It was obvious that, by increasing cell width from 2 cm to 4 cm, the seedlings feeding rate increased from 83 to 105 and from 73 to 90 seedling/min at linear speed of 0.208 m/s, speed ratio of 1 and at seedlings diameter of (≤ 5 and ≥ 10 mm) respectively.

On the other hand, as shown in Figure (3), at all linear speeds and cell widths of feeding belt, increasing seedlings bulb diameter tends to decrease seedlings feeding rate due to the decrease in opportunities of seedlings to fall in cells of feeding belt when seedlings bulb diameter increased. From the data, it was noticed that, by increasing seedlings bulb diameter from 5 to more than 10 mm, the seedlings feeding rate decreased from 83 to 73 and from 137 to 118 seedling/min at cell width of 2 cm, speed ratio of 1 and linear speed of 0.208 and 0.416 m/s respectively.

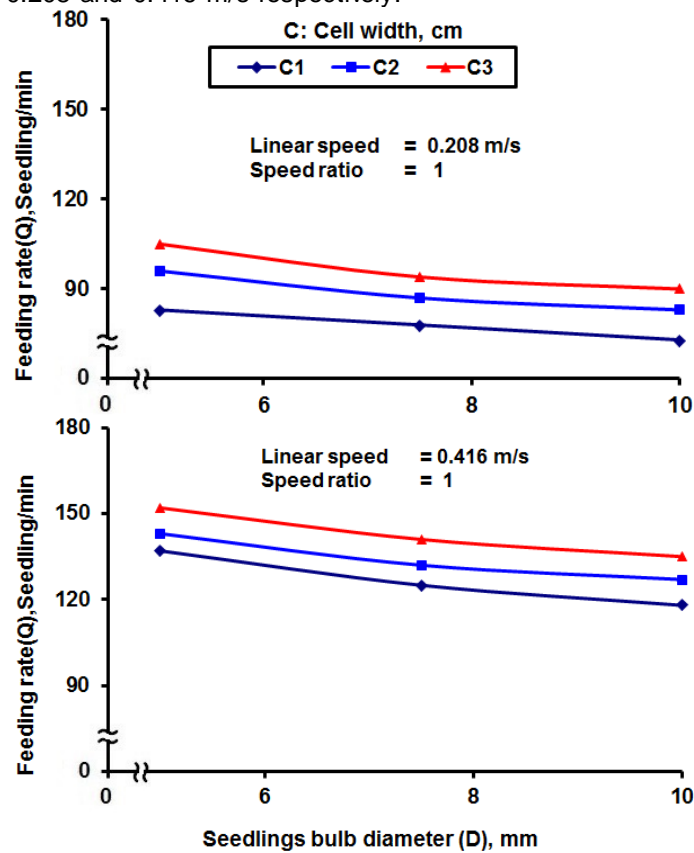

Figure (3): Effect of Seedlings diameter and cell width on feeding rate at different linear speeds.

As shown in Figure (4), it was noticed that, speed ratio has no effect on seedlings feeding rate because it does not affect feeding process anywhere, it was essentially responsible for seedlings spacing. When speed ratio increased from 1 to 2.63, seedlings feeding rate approximately stayed near the same value of (83-81) and (115-116 seedling/min) at cell width of 2 cm, linear speed of (0.208 and 0.416 m/s) and Seedlings diameter of (≤ 5 and ≥ 10 mm) respectively.

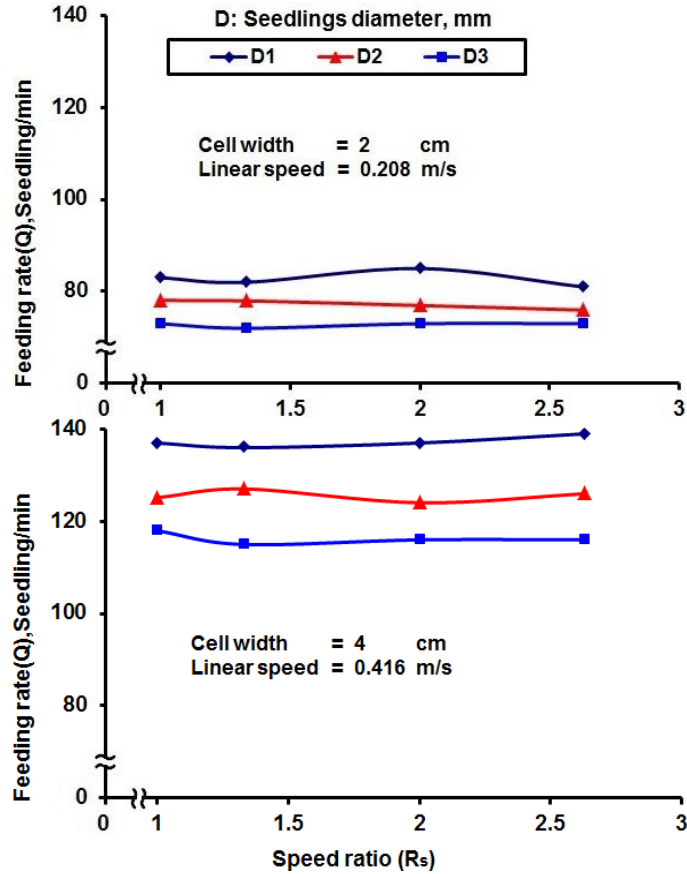

Figure (4): Effect of Seedlings diameter and speed ratio on inclined seedlings percentage at different linear speeds and cell widths.

2- Inclined seedlings percentage:

It is clear that, increasing the linear speed of feeding belt tends to increase inclined seedlings slightly for all cell widths at different seedling bulb diameters due to increase in seedlings deviation as a result of feeding belt speed increase. As shown in Figure (5), it was noticed that, by increasing the linear speed from 0.208 to 0.347 m/s, the inclined seedlings percentage increased from 2.7 to 4.82 and from 3.62 to 5% at speed ratio of 1, seedlings diameter of (≤ 5 and ≥ 10 mm) and cell width of 2 and 4 cm respectively.

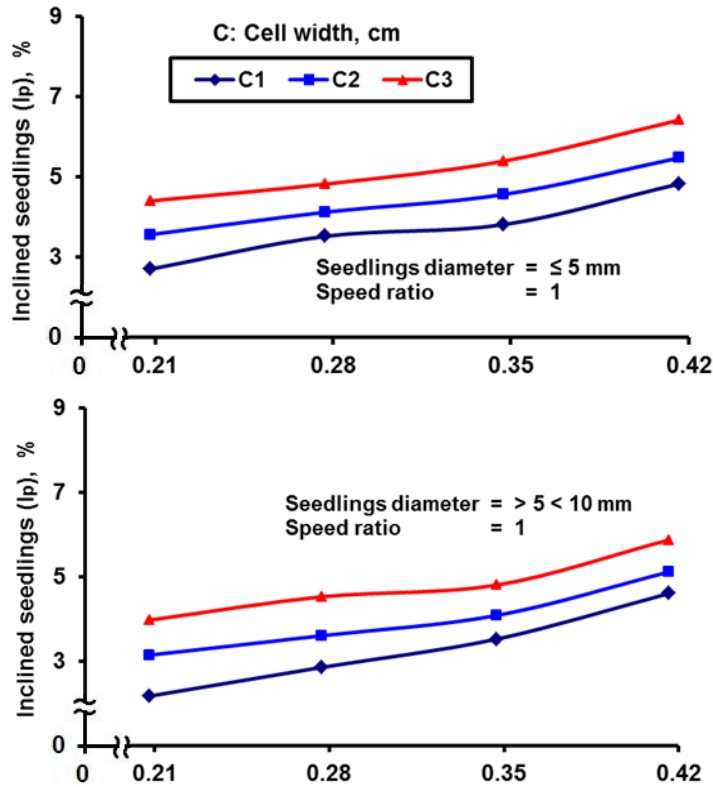

Figure (5): Effect of linear speed and cell width on inclined seedlings percentage at different seedlings bulb diameters.

Also, as shown in Figure (5), at all linear speeds and seedling bulb diameters, increasing cell width of feeding belt tends to increase inclined seedlings percentage due to increase in cell space of feeding belt which enhance seedlings deviation as a result. On the other hand, at all linear speeds and cell widths of feeding belt, increasing seedlings bulb diameter tends to decrease inclined seedlings percentage slightly. This happened because of the big seedlings bulb diameters have less tangle between themselves than the small, which decrease ability to deviation of seedlings when traveling on the belt surface. As shown in Figure (6), it was obvious that, by increasing cell width from 2 cm to 4 cm, the inclined seedlings percentage increased from 2.7 to 4.4 and from 3.64 to 5 % at speed ratio of 1, linear speed of 0.208 and 0.416 m/s and seedlings bulb diameter of (≤ 5 and ≥ 10 mm) respectively. On the other hand, inclined seedlings percentage decreased from 2.7 to 2.05 and from 4.82 to 3.64 % at speed ratio of 1, cell width of 2 cm and linear speed of 0.208 and 0.416 m/s respectively when seedlings bulb diameter increased from 5 to more than 10 mm as show in Figure (6).

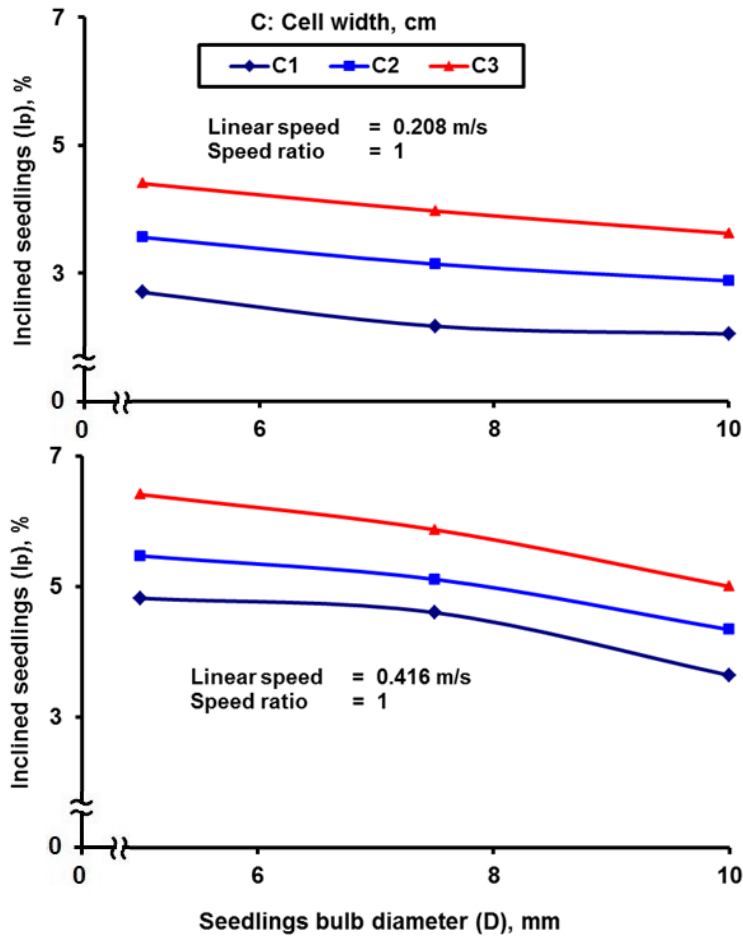

Figure (6): Effect of Seedlings bulb diameter and cell width on inclined seedlings percentage at different linear speeds.

From the data in Figure (7), it was noticed that, increasing speed ratio has a clear effect on inclined seedlings percentage because of the high difference in linear speed between both of feeding belt and conveyor belt. This causes a marked increase in inclined seedlings percentage with increasing relative linear speed. It was noticed that, when speed ratio increased from 1 to 2.63, inclined seedlings percentage increased from 2.7 to 4.75 and from 5 to 7.59 % at seedlings bulb diameter of (≤ 5 and ≥ 10 mm), linear speed of 0.208 and 0.416 m/s and cell width of 2 and 4 cm respectively.

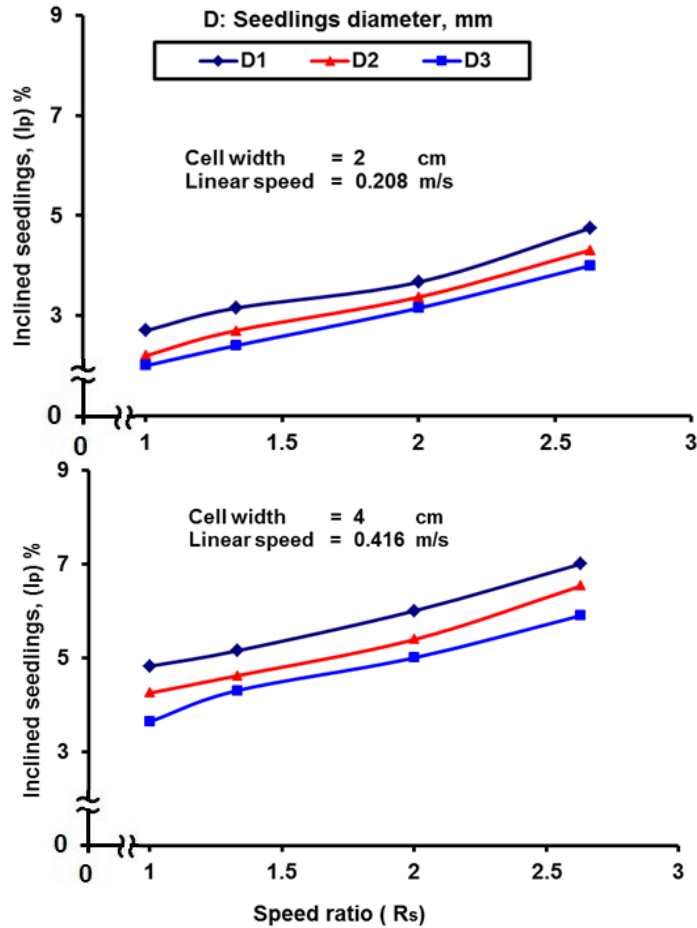

Figure (7): Effect of Seedlings diameter and speed ratio on inclined seedlings percentage at different linear speeds and cell widths.

3- Damaged seedlings percentage:

It was noticed that, increasing the linear speed of feeding belt tends to increase damaged seedlings percentage for all cell widths at different seedling bulb diameters due to increase in exposure speed of seedlings to both of hopper gates and belt cells, which means more shocks to seedlings and as a result, more damaged. As shown in Figure (8), by increasing the linear speed from 0.208 to 0.416 m/s, the damaged seedlings percentage increased from 3.5 to 5.8 and from 0 to 1.1% at speed ratio of 1, seedlings diameter of (≤ 5 and ≥ 10 mm) and cell width of 2 and 4 cm respectively. Also, at all linear speeds and seedling bulb diameters, increasing cell width of feeding belt tends to decrease damaged seedlings percentage due to the decrease in seedlings exposed to shocks by increasing cells space that seedlings fall in on the feeding belt out surface.

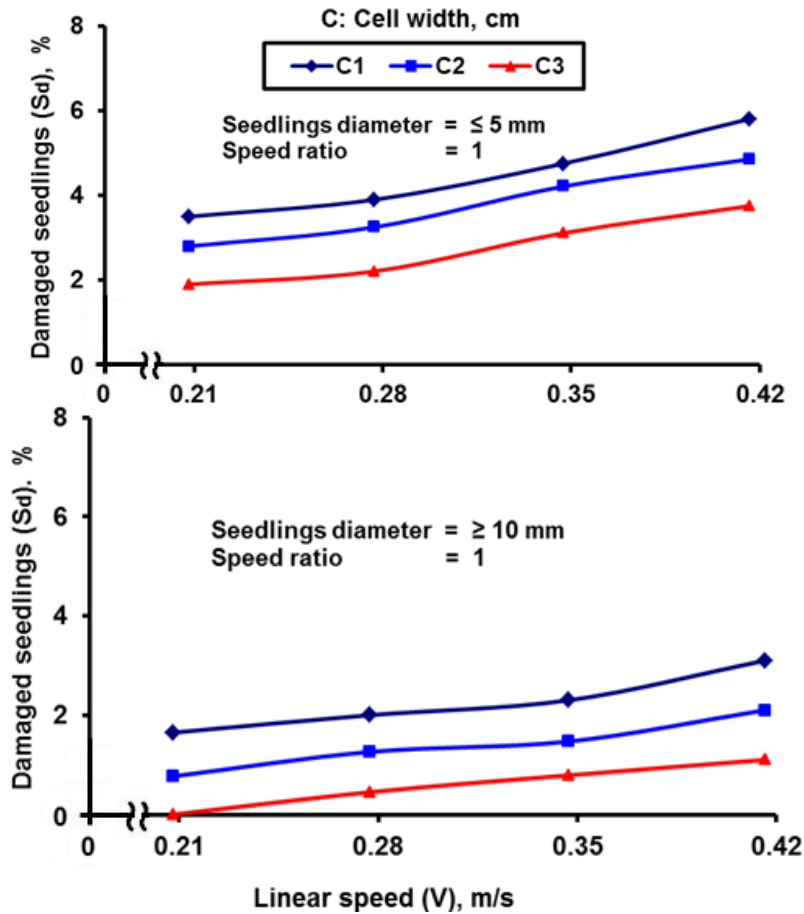

Figure (8): Effect of linear speed and cell width on damaged seedlings percentage at different Seedling diameters.

As shown in Figure (8), it was obvious that, by increasing cell width from 2 cm to 4 cm, the damaged seedlings percentage decreased from 3.5 to 1.9 and from 3.1 to 1.1 % at speed ratio of 1, linear speed of 0.208 and 0.416 m/s, and seedlings diameter of (≤ 5 and ≥ 10 mm) respectively. Also, at all linear speeds and cell widths of feeding belt, increasing seedlings bulb diameter tends to decrease damaged seedlings percentage due to decreasing the tangle between seedlings at large bulb diameters which decrease seedlings exposed to damage as a result. Data showed that, the damaged seedlings percentage decreased from 3.5 to 1.65 and from 5.8 to 3.1 % at speed ratio of 1, cell width of 2 cm and linear speed of 0.208 and 0.416 m/s respectively, when seedlings bulb diameter increased from 5 to more than 10 mm.

From the data in Figure (9) it was noticed that, increasing speed ratio has no significant effect on damaged because, seedlings was exposed to

damage before reaching conveyor belt which have a changeable linear speeds, and essentially, it was responsible for seedlings spacing and inclined seedlings percentage as mentioned before. As shown in Figure (9), when speed ratio increased from 1 to 2.63, damaged seedlings percentage approximately stayed near the same value of (3.5 - 3.45 %) at linear speed of 0.208 m/s, seedlings diameter of (≤ 5 mm), cell width of 2 cm.

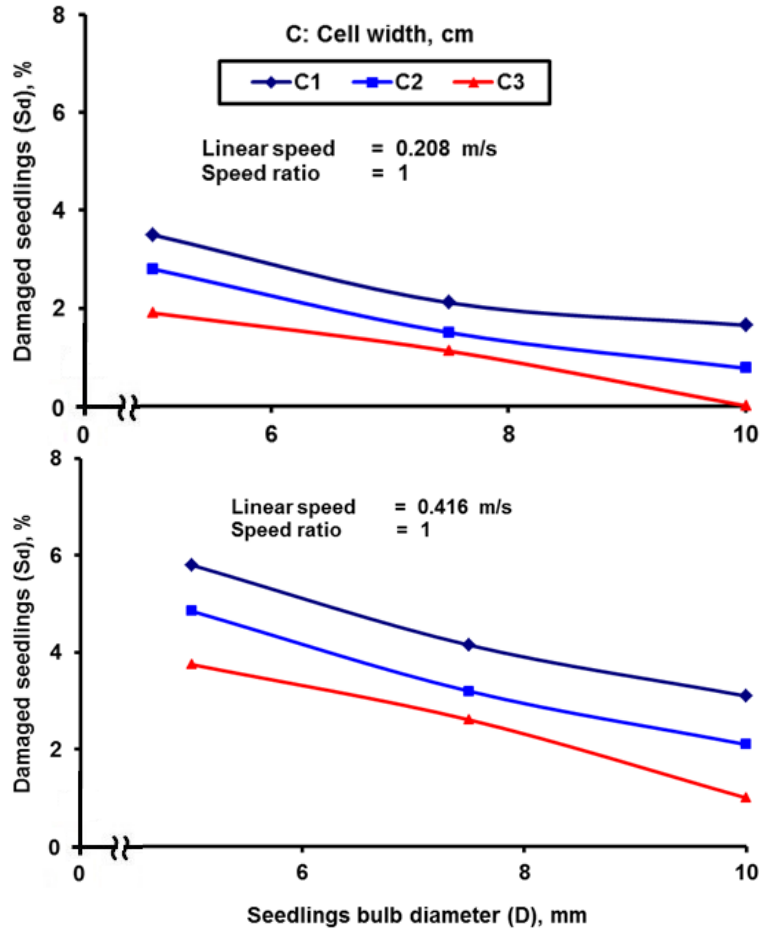

Figure (9): Effect of Seedlings bulb diameter and cell width on damaged seedlings percentage at different linear speeds.

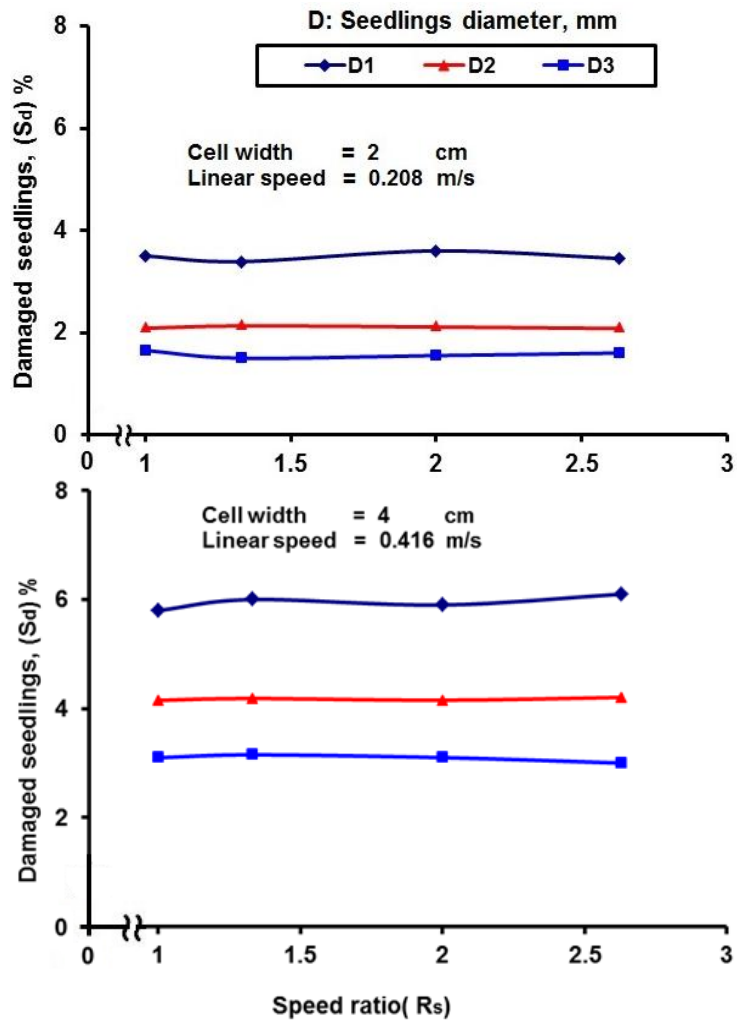

Figure (10): Effect of Seedlings diameter and speed ratio on damaged seedlings percentage at different linear speeds and cell widths.

4- Average seedlings spacing:

As shown in Figure (11), It was obvious that, increasing the linear speed of feeding belt tends to increase average seedlings spacing for all cell widths at different seedling bulb diameters. This can be explained as when linear speed increased, filling of belt cells decreased in spite of increasing seedlings disposed rate, but not at the same rate of increasing linear speed, which means finally increasing in average seedlings spacing. From the data, it was clear that, by increasing the linear speed from 0.208 to 0.416 m/s , the average seedlings spacing increased from 6.33 to 10 and from 10.5 to 15.67 cm at speed ratio of 1, seedlings diameter of (≤ 5 and ≥ 10 mm) and cell width of 2 and 4 cm respectively. Also, as shown in Figure (11), at all linear speeds and seedling bulb diameters, increasing cell width tends to increase

average seedlings spacing due to the increase in cell space which increases the distance between seedlings on the feeding belt and as a result, increases average seedlings distance. Data showed that, by increasing cell width from 2 to 4 cm, the average seedlings spacing increased from 6.33 to 9.5 and from 10.416 to 15.67 cm at speed ratio of 1, linear speed of 0.208 and 0.416 m/s and seedlings diameter of (≤ 5 and ≥ 10 mm) respectively. As shown in Figure (12), at all linear speeds and cell width, increasing seedlings bulb diameter tends to increase slightly average seedlings spacing, due to decreasing the tangle between seedlings at high bulb diameters which increases the distance between them on the feeding belt and subsequently, increasing average seedlings spacing. Data showed that, the average seedlings spacing increased from 6.33 to 7.33 and from 10 to 10.416 cm at speed ratio of 1, cell width of 2 cm and linear speed of 0.208 and 0.416 m/s respectively, when seedlings bulb diameter increased from 5 to more than 10 mm.

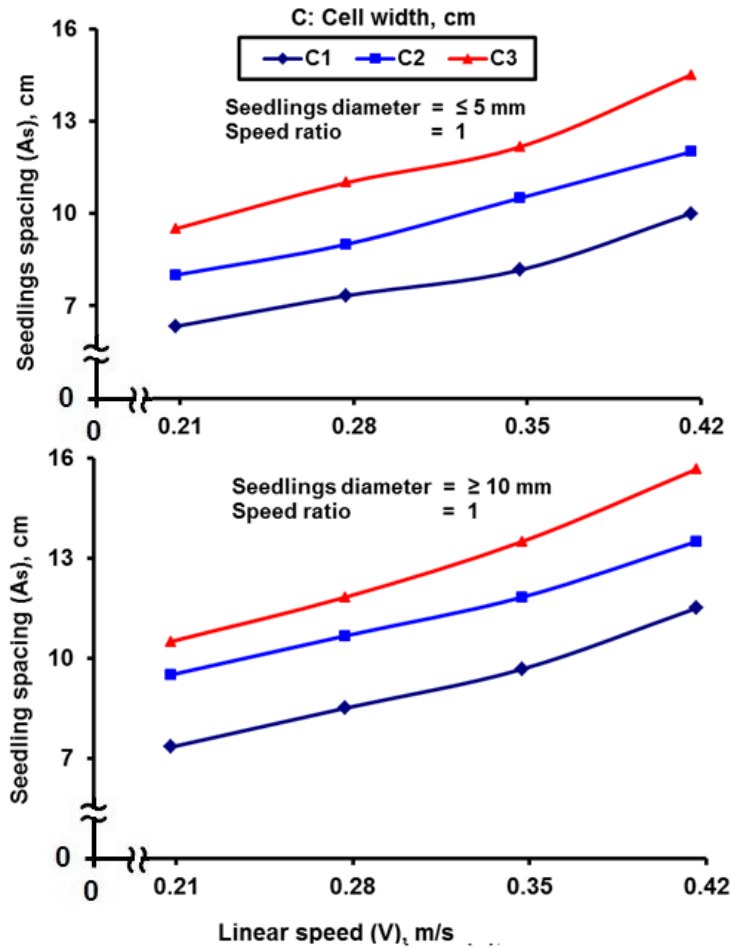

Figure (11): Effect of linear speed and cell width on average seedlings spacing at different Seedling diameters.

From the data in Figure (13), it was clear that, increasing speed ratio have very clear significant effect on average seedlings spacing due to the obvious difference between both of feeding belt and feeding drum speed and conveyor belt speed which leads to increase the distance between seedlings and as a result increases average seedlings spacing. As shown in Figure (14), when speed ratio increased from 1 to 2.63, average seedlings spacing increased from 6.33 to 16 cm at seedlings bulb diameter of (≤ 5 mm), linear speed of 0.208 m/s. and cell width of 2 cm.

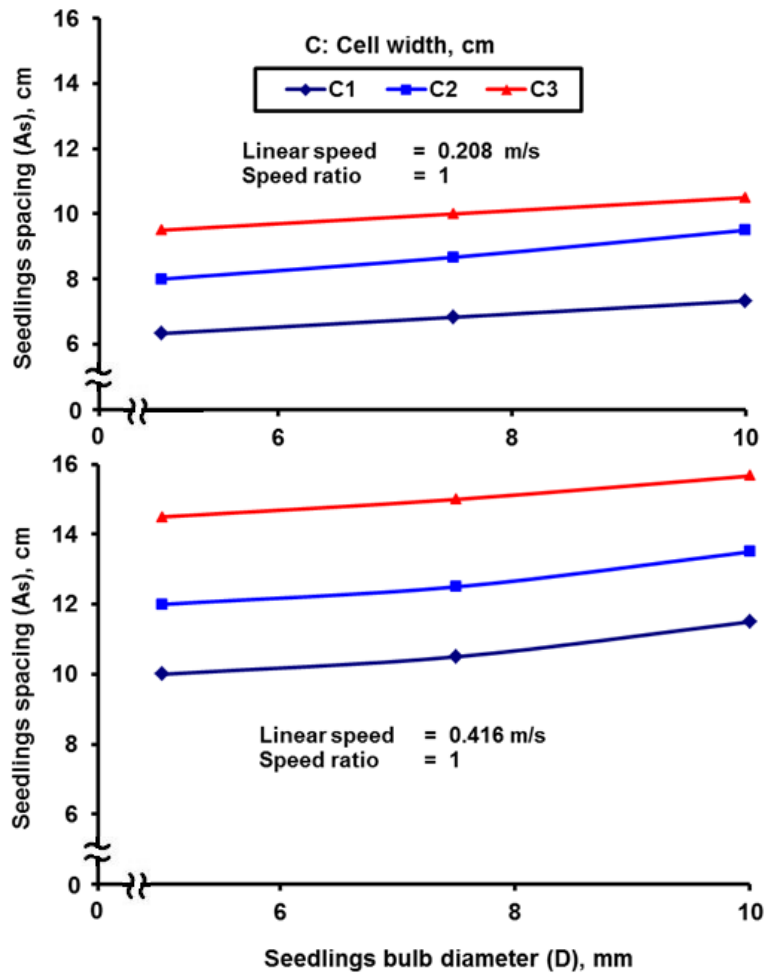

Figure (12): Effect of Seedlings bulb diameter and cell width on average seedlings spacing at different linear speeds.

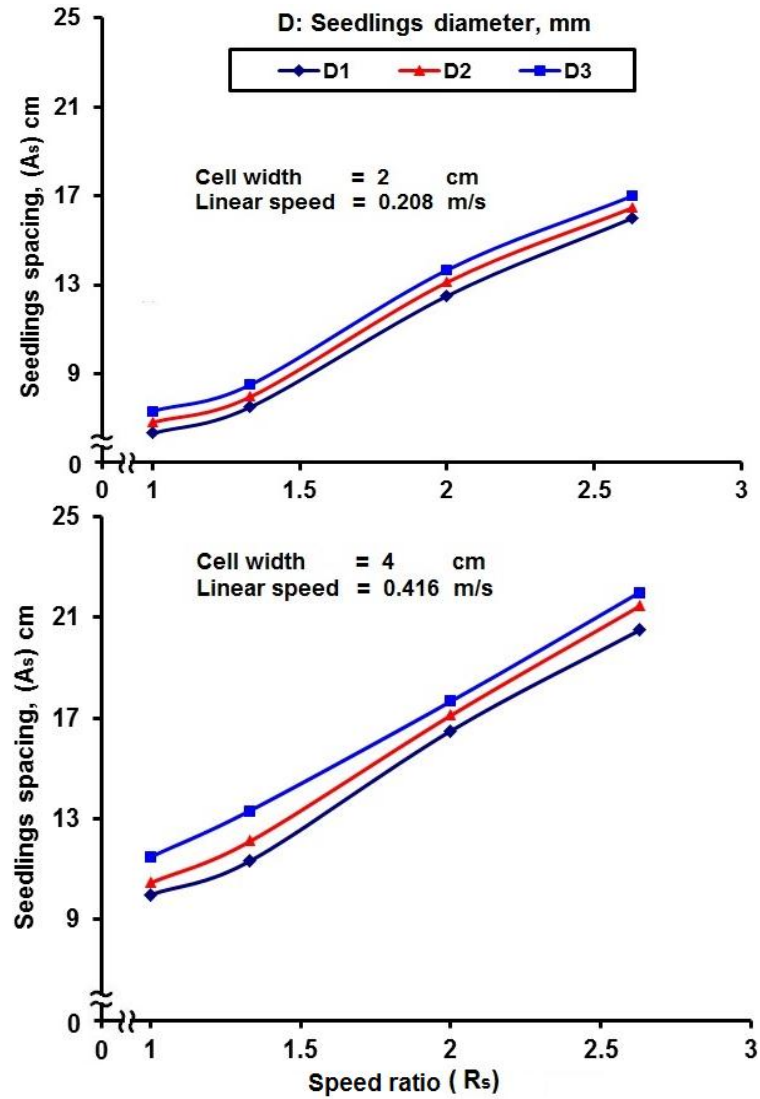

Figure (13): Effect of Seedlings diameter and speed ratio on average seedlings spacing at different linear speeds and cell widths.

Determination of power required:

The consumed power (kW) for the fourth linear speeds of feeding belt used in this study to run the prototype of mechanical feeding unit during the test operation shown in Figure (14). It was clear that, the useful power consumed stayed at a constant value of 0.0994 kW at the three linear speeds of 0.208, 0.277 and 0.347 m/s, then it quickly increased from 0.0994 to 0.1491 kW at the higher linear speed of 0.416 m/s.

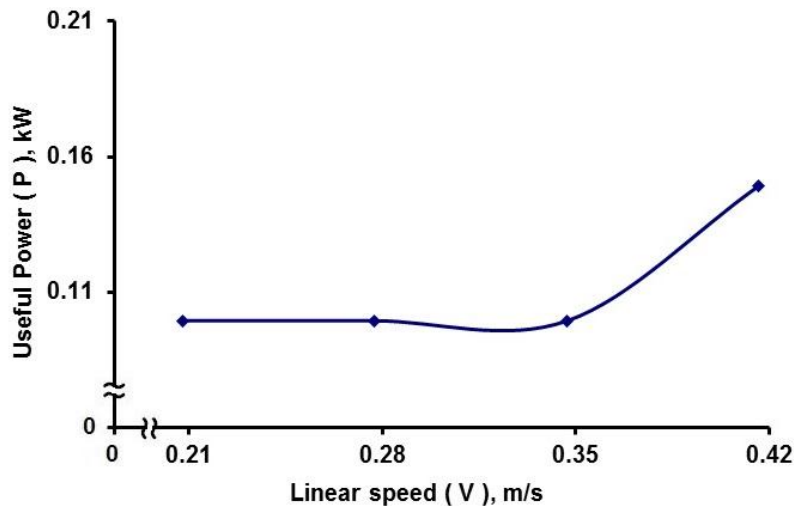

Figure (14): Useful power consumed at different linear speeds.

SUMMARY AND CONCLUSION

From this study, the optimum recommendation values suitable for onion seedlings transplanting for the following parameters were as follows:

- 1-Linear speed of feeding belt of 0.347 m/s,
- 2-Speed ratio between conveyor belt and feeding belt of 1.33,
- 3-Seedlings bulb diameter of $> 5 < 10$ mm and
- 4-Cell width of 3 cm.

To achieve a satisfactorily results of seedlings feeding rate (153 seedling/min), inclined (4.72 %) and damaged seedlings (3 %) percentages within the limits permitted, the recommend seedlings spacing for onion crop (10 cm) and useful power consumed of (0.0994 kW).

REFERENCES

- Choi, W. C., Kim, D. C., Ryu, I. H. and Kim, K. U. (2002) Development of a seedling pick-up device for vegetable transplanters. *J. Transactions of the ASAE.* (45) 1: 13-19.
- Dhaliwal, I. S., Kumar, N. M. and M. G. Singh (2011) Development and Evaluation of a Two-Row Revolving Magazine Type Vegetable Transplanter. *J. of Agric. Eng.* Volume 48 (3): 1-7.
- Egypt statistical Yearbook, (2013) C.A.P.M.A.S. PP: 10.
- Hu, M. J. and Yin, W. Q. (2011) Experimental research on the deformed sliding needle pick-up device for plug seedlings. *J. of Acta Agriculture Zhejiangensis* (23) 1: 154-158.
- Ibrahim, M.K. (1982). Wet milling of wheat grain. M. Sc. Thesis Fac. of Agric., Mansoura Univ., Egypt.

- Kim H. J., Park T. Y. and T.Y. Kwak (2001) Development of an automatic transplanter for cabbage cultivation. Korea ADAMS User Conf. PP: 1-18.
- Kumar, G. V. P. and Raheman, H. (2012) Automatic feeding mechanism of a vegetable transplanter. International Journal of Agricultural and Biological Engineering. (5) 2 : 20-27.
- Li-gang QIU and YU Gao-hong (2012) Design and Test of a Seedling-delivering Device on an Automatic Transplanter for Pots of Vegetable Seedlings. J. of Zhejiang Institute of science and Technology (5) : 683-687 .
- Lin, W. C., Chern, B., Lin, S. and Luan, J. (2000) Development of self-propelled automatic transplanter for vegetable seedlings. J. Agriculture and Forestry (49) 1: 15-32.
- Sakaue O. (1996) Development of seedling production robot and transplanter system. J. of (JARQ) Japan Agricultural Research Quarterly Vol. 30 : 221-226.

تطوير وحدة تغذية آلية تناسب شتلات البصل

محمد أحمد الشبيخة*، حسني الشبراوي المرسي*، سامي السعيد بدر** و
وائل محمد زكي البلخي**
* قسم الهندسة الزراعية - كلية الزراعة - جامعة المنصورة - مصر .
** معهد بحوث الهندسة الزراعية - مركز البحوث الزراعية - مصر .

تم في هذا البحث تطوير وحدة تغذية آلية لشتلات البصل بواسطة سير أفقي ذو خلايا على أن تناسب هذه الوحدة الشتلات النصف آلية ذات السير الناقل بهدف رفع الكفاءة والسعة الحقلية لها وتم دراسة بعض العوامل التشغيلية لهذه الوحدة كانت كما يلي : السرعة الخطية لسير التغذية، السرعة النسبية بين السير الناقل وسير التغذية و عرض خلايا سير التغذية بالإضافة إلى أقطار الأوصال المستخدمة في الدراسة. تم دراسة تأثير هذه العوامل على خصائص الشتلات المارة من وحدة التغذية الآلية ، وكذلك القدرة المستهلكة لإدارة وحدة التلقين باستخدام المخروطة كمصدر للقدرة ، وتم تنفيذ الدراسة بطريقة معملية في ورشة بقرية ميت علي بالدقهلية وكانت أهم النتائج كما يلي :

- ١- تأثير السرعة الخطية لسير التغذية: زيادتها أدت إلى زيادة معدل تغذية الشتلات، زيادة نسبة الشتلات المائلة عن زاوية ٣٠° ، زيادة نسبة الشتلات المتضررة وكذلك زيادة متوسط المسافة بين الشتلات على السير الناقل بنسبة قليلة.
- ٢- تأثير السرعة النسبية: زيادتها كان لها دور رئيسي في زيادة متوسط المسافة بين الشتلات ، زيادة نسبة الشتلات المائلة بينما لم يلاحظ لها تأثير معنوي على كل من معدل تغذية الشتلات ونسبة الشتلات المتضررة.
- ٣- تأثير أقطار الأوصال: زيادة أقطار الأوصال أدت إلى تقليل كلا من معدل تغذية الشتلات، نسبة الشتلات المائلة و نسبة الشتلات المتضررة بينما أدت زيادتها إلى زيادة متوسط المسافة بين الشتلات بنسبة قليلة.
- ٤- تأثير عرض خلايا سير التغذية: زيادة عرض خلايا سير التغذية أدت إلى زيادة كلا من معدل تغذية الشتلات، نسبة الأوصال المائلة وكذلك متوسط المسافة بين الشتلات. بينما أدت إلى تقليل نسبة الشتلات المتضررة.
- ٥- القدرة المستهلكة: ظلت قيمة القدرة الفعلية المستهلكة بالكيلووات لتشغيل وحدة التغذية الآلية ثابتة عند قيمة قدرها (٠.٩٩٤ كيلووات) عند التشغيل على السرعات الثلاث الخطية (٠.٢٠٨، ٠.٢٧٧ و ٠.٣١٧ م/ث) وعند التشغيل على أعلى سرعة خطية قدرها (٠.٤١٦ م/ث) زادت قيمة القدرة المستهلكة بسرعة إلى قيمة قدرها (٠.١٤٩١ كيلو وات).

ويوصى عند تشغيل هذه الوحدة على شتلات البصل أن يتم ضبطها على العمل وفق المتغيرات التالية:

- ١- سرعة خطية لسير التغذية في حدود ٠.٣٧٧ م/ث،
 - ٢- سرعة نسبية بين السير الناقل وسير التغذية تبلغ (١.٣٣)،
 - ٣- أقطار أوصال في حدود (١٠ > ٥ < مم) وكذلك
 - ٤- عرض خلايا سير التغذية في حدود (٣ سم).
- وذلك للوصول لنتائج مقبولة من حيث نسبة ضرر الشتلات (٣٪) ونسبة الشتلات المائلة (٤.٧٢٪) في حدود المسموح وكذلك معدل تغذية جيد للشتلات (١٥٣ شتلة/دقيقة) و المسافة الموصى بها لزراعة شتلات البصل وتكون في حدود (١٠سم) وكذلك أقل استهلاك للقدرة (٠.٩٩٤ كيلووات).