

## Dynamic Performance of Fuel Cell DG System with Voltage Quality Improvement Capability

الأداء الديناميكي لنظام توليد لامركزي من خلايا الوقود مع قابلية تحسين جودة الجهد

M. S. Kandil, M. M. El-Saadawi, A. E. Hassan, K.M.Abo-Al-Ez

Dept. of Electrical Engineering  
Faculty of Engineering, Mansoura University

ملخص البحث:

لقد حظت نظم التوليد اللامركزية على اهتمام كبير في السنوات الأخيرة نظرا لاعادة بناء و خصخصة نظم القوى الكهربائية، بالإضافة الى ان زيادة الأحمال والحاجة لحماية البيئة تعتبر من أهم العوامل المشجعة على تطوير نظم طاقة بديلة للمستهلك. ومن أهم هذه الأنواع خلايا الوقود، حيث تجتذب حاليا اهتماما متزايدا لمميزاتها الاقتصادية والتقنية. ويتسبب ربط نظم التوليد اللامركزية بمغذيات شبكة التوزيع ذات الجهد المتوسط في ارتفاع في الجهد عند نقطة الربط المشتركة. وباستخدام نظام تحكم مناسب وزيادة حجم قدرة العكس (inverter)، فإن نظم التوليد اللامركزية وبخاصة خلايا الوقود يمكنها ان تمتلك القدرة على تبادل القدرة الغير فعالة و بالتالي تنظيم الجهد. هذا البحث يناقش الأداء الديناميكي لنظم خلايا الوقود للتوليد اللامركزي المحتوية على تعويض القدرة الغير فعالة لإدارة جودة الجهد الكهربائي، سواء كان مصدر اختلال الجهد نتيجة عن الربط مع شبكة التوزيع أو لأي سبب آخر. و يتعرض البحث نظاما متكاملًا من خلايا الوقود و معوض القدرة الغير فعالة مرتبط بمغذي ذو جهد متوسط وقد تمت دراسة و اختبار هذا النظم في ظروف التشغيل المعتادة و في حالات انخفاض و ارتفاع الجهد و حالات اهتزاز الجهد. يقدم البحث نماذج ديناميكية مقترحة لمكونات النظام، كما يقترح نظاما للتحكم متعدد المستويات و يوضح نموذجا لتصلبها للعكس المستخدم بالربط بالشبكة و لأغراض تعويض القدرة الغير فعالة. ولأثبت دقة النموذج و نظام التحكم المقترح تم بناء شبكة اختبار من خلال بيئة المتكامل سيمولينك (MATLAB/Simulink). وقد أوضحت النتائج الأداء الفعال لنظام التحكم المقترح متعدد المستويات ومميزاته في تنظيم جودة الجهد الكهربائي في وجود خلايا الوقود.

### Abstract

Decentralized Generation (DG) systems have received increased attention in recent years due to the restructuring and deregulation of electric power systems and markets. In addition, rapid increase in electric power demand and the need for environment conservation are major driving factors for developing alternative energy sources at the consumer level. Fuel Cells (FCs) are one of the most important DG types due to their technical, economical and environmental advantages. The connection of DGs to medium voltage distribution feeders causes voltage rise at the point of common coupling. With proper control algorithm and oversizing of the inverters, DGs would have the ability to exchange reactive power and hence regulate voltage. This paper discusses the dynamic performance of Fuel Cell DG system integrated with Static VAR compensation capability, for voltage quality management, whether the voltage disturbance is caused by interconnection of DG to the distribution grid or any other reason. The proposed integrated FC/Static VAR compensator system is tested for normal FC grid connected operation, for cases of voltage sags and swells, and voltage flicker. Modeling and control approaches are proposed, including a detailed modeling of the AC/DC inverter configuration used for grid interconnection and compensation purposes. A multi-level control technique is proposed based on the instantaneous power theory. Validation of the models and control schemes is carried out using a test system built with MATLAB/Simulink. The results demonstrate the effective performance of proposed controller, as well as the benefits of its use in distribution network voltage quality management in the presence of FC DG units.

**Key words:** Decentralized Generation (DG), Fuel Cell (FC), voltage quality, multilevel control.

### 1. Introduction

Decentralized Generation (DG) systems are attracting a lot of attention in recent years due to the restructuring and deregulation of electric power systems and markets. Fuel Cells (FC) are among the most promising DG types for the residential and small commercial users. Being very close to the end users, the FCs offer reliability, energy independence, "green" power, and ultimately, lower energy costs [1]. These attributes give fuel cell DG great market potential. Therefore, it is encouraged to develop FCs as an economically viable grid-connected DG option [2]. A fuel cell operates like a battery by converting the chemical energy from reactants into electricity, but it differs from a battery in that as long as the fuel (such as hydrogen) and an oxidant (such as oxygen) is supplied, it will produce DC electricity (plus water and heat) continuously, as shown in Fig.1 [1]. A proposed generalized Simulink FC DG model is presented by the authors to dynamically model any FC type in [3].

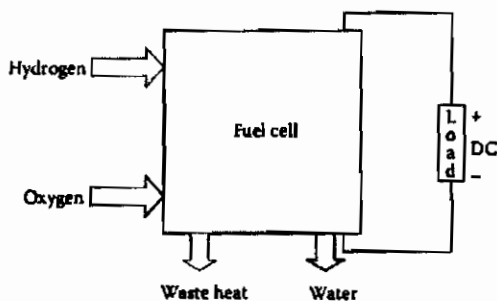

Fig.1 FC inputs and outputs [1].

In passive distribution systems, a single distribution substation typically serves several radial lines to which many consumers are connected [4]. The voltage on these lines gradually decreases so that at the end of the line, the voltage is lower than that at the substation. In order to ensure that even the most distant consumer receives an adequate voltage, even when consumption is high, Distribution System Operators (DSOs) normally set the voltage at the substation towards the high end of the permitted range [5].

When a DG unit is installed near the remote end of such a radial line, current is injected into the line, reducing or even reversing the flow of power drawn from the substation. DGs are usually being operated at or near Unity Power Factor (UPF) [6], and they usually have little impact on the reactive power production or absorption [7], [8].

For a system with load and DG as shown in Fig.2, the voltage drop on the feeder can be approximated by:

$$\Delta V = V_1 - V_2$$

$$\Delta V \approx \frac{R_{LN}(P_L - P_{DG}) + X_{LN}(Q_L - (\pm Q_{DG}))}{V_2} \quad (1)$$

Where:

- $\Delta V$  : Voltage drop across the feeder (V).
- $V_1$  : Substation terminal voltage (V).
- $V_2$  : Point of common coupling voltage (V).
- $R_{LN}$  : Feeder resistance ( $\Omega$ ).
- $X_{LN}$  : Feeder reactance ( $\Omega$ ).
- $P_L$  : Load active power (W).
- $Q_L$  : Load reactive power (VAR).
- $P_{DG}$  : DG active power (W).
- $Q_{DG}$  : DG reactive power (VAR).

Eq. (1) indicates that DG active power generation will always decrease the voltage drop along the feeder, thus causing voltage rise. Further, Eq. (1) indicates that, if the DG exchanges reactive power, it can either increase or decrease the voltage drop.

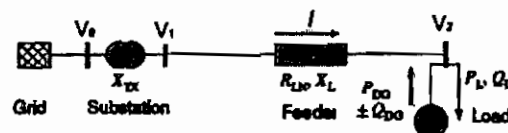

Fig.2 Single line diagram of a DG connected to a distribution feeder

Different methods have been addressed to mitigate the voltage rise problem in the presence of DG [8]-[13]. Some authors as in [8] and [9], proposed the installation of a step Voltage Regulator (VR) on the feeder to solve unacceptable voltage variations. Voltage rise can also be mitigated by operating DG in leading power factor to absorb reactive power from the grid [10]. Further, operating feeders in

a closed loop can also solve unacceptable voltage variations by balancing the voltage between the feeders in the loop [11]. These voltage rise mitigation methods will lead to a larger DG installation potential in the distribution system. However, VR installation means an additional investment cost. DG absorbing reactive power needs reactive power sources somewhere else in the system that will increase losses. Closed loop feeder operation needs attention on the short circuit capacity and protection of the feeder.

Some recent literature [12]-[13], have addressed the hybrid operation of FC system with storage batteries. Authors of [12] presented the dynamic behavior of a Solid Oxide FC (SOFC) power plant including a Static VAR Compensator (SVC) for reactive power flow control. In this study, SOFC power plant is operated for active power generation, while the reactive power requirement is supplied or absorbed separately by the SVC system. Due to this separation, there is no interaction between the reactive power and DC side of the FC DG system since the reactive power is absorbed or injected only in AC side. Authors of [13] discussed a quite opposite approach to [12] where the storage battery is connected to the same DC link of the FC. They proposed a fuzzy logic control strategy for the hybrid fuel cell/energy storage DG system is used to enhance the DG system performance during voltage sag in distribution system. Whether connected on the DC or AC side of the FC DG system, both systems in [12] and [13] has the drawbacks of an extra cost for adding a separate reactive power compensation devices and their separate control algorithms. These drawbacks necessitate the use of a FC DG with a dual active/reactive power management operation. This dual operation would add flexibility to the FC DG and makes it cost effective.

FC DG is interfaced to the electric grid using power electronics inverter. With a proper control strategy, this inverter

would be responsible for grid integration and power management. Although conventionally the range of the reactive power supply from inverters is limited [6], it is possible to oversize the inverters to supply reactive power in a much larger range. Oversizing of the inverter will significantly increase the range of reactive power supply, especially for FC DG inverters [2], [14].

This paper proposes a multi-level inverter interface controller for a proposed integrated FC/Static VAR compensator system. The proposed controller will comply with the grid integration requirements for supplying active power, as well as supplying reactive power. The reactive power supplied is used to compensate different voltage disturbances. The dynamic performance of the proposed integrated system and its proposed controller is thoroughly analyzed and verified using a test system built using MATLAB Simulink and SimpowerSystem blocks.

## 2. Proposed Integrated System

### 2.1 System Components

The proposed integrated FC/Static VAR system is shown in Fig.3, as follows:

- 1- SOFC DG modules.
- 2- Split DC link capacitor of the inverter.
- 3- A 3-phase shunt-connected controlled Voltage Source Inverter (VSI).
- 4- A coupling transformer.
- 5- A line connection filter.
- 6- A multi-level controller.

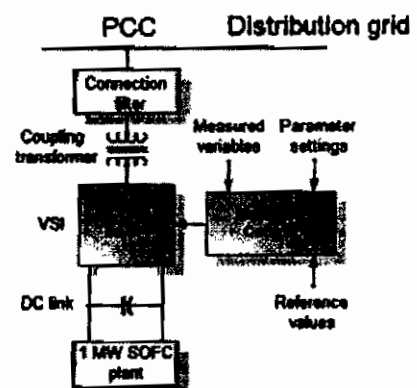

Fig.3 The integrated FC/Static VAR compensator

In the distribution network, the switching device of the VSI is generally an Insulated Gate Bipolar Transistor (IGBT) due to its lower switching losses and reduced size [15]. As a result, the control of the output voltage of the integrated FC/Static VAR compensator can be achieved through pulse width modulation (PWM) by using high-power fast-switched IGBTs [16]. The VSI structure is designed to make use of a three phase two level double bridge structure [17]. The low pass filters is used to reduce the perturbation on the distribution system from high-frequency switching harmonics generated by PWM control. The total harmonic distortion (THD) of the output voltage of the inverter combined with a sine wave filter should be less than 5 % at full rated unity power factor load [18]. Typically, leakage inductances of the step-up transformer windings are high enough as to build the sine wave filter simply by adding a bank of capacitors in the Point of Common Coupling (PCC). In this way, an effective filter is obtained at low costs, permitting to improve the quality of the voltage waveforms introduced by the PWM control to the power utility and thus meeting the requirements of IEEE Standard 519-1992 relative to power quality [19].

**2.2 The Proposed Multi-level Control Scheme**

The proposed multi-level control scheme for the integrated FC/Static VAR system consists of three levels, as shown in Fig.6:

- 1- External level: is responsible for determining the active and reactive power exchange between the integrated FC/Static VAR compensator, and the medium voltage distribution grid.
- 2- Middle level: makes the expected output to dynamically track the reference values set by the external level.
- 3- Internal level: is responsible for generating the switching signals for the twelve gates of IGBTs of the three-level VSI.

The measured current and voltage values in *abc* frame is converted to the synchronous-rotating *dq* reference frame values based on concepts of instantaneous power theory [20] as depicted in Fig.4. Rotating reference frame is used in the proposed controller because it offers higher accuracy than stationary frame-based techniques [21]. All blocks make use of control variables that are feasible to be locally measured.

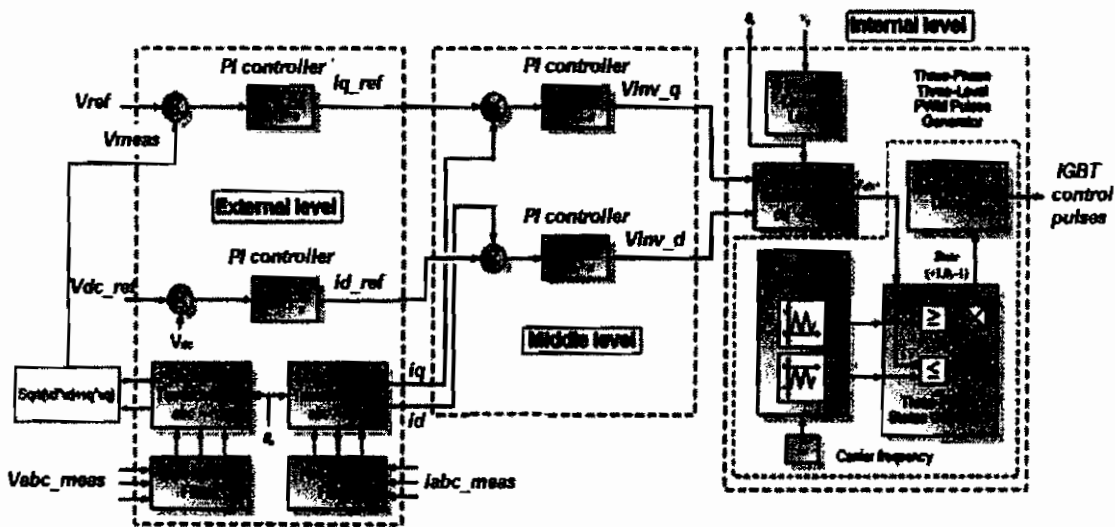

Fig.4 The proposed multi-level control scheme for the integrated FC/Static VAR compensator

### 2.2.1 External level control

The first control loop of the external level is applied for controlling the voltage at the PCC of the integrated FC/Static VAR system terminals through the modulation of the reactive component of the output current. To achieve this objective, the instantaneous voltage at the PCC is computed by using a synchronous-rotating orthogonal reference frame. The instantaneous values of the three-phase AC bus voltages are transformed into  $dq$  components,  $v_d$  and  $v_q$ , by applying Park's transformation. The transformation equation is of the form:

$$[v_{dq0}] = [T_{dq0}(\theta_s)][v_{abc}] \quad (2)$$

Where the dq0 transformation matrix is defined as:

$$[T_{dq0}(\theta_s)] = \sqrt{\frac{2}{3}} \begin{bmatrix} \cos \theta_s & \cos(\theta_s - \frac{2\pi}{3}) & \cos(\theta_s + \frac{2\pi}{3}) \\ -\sin \theta_s & -\sin(\theta_s - \frac{2\pi}{3}) & -\sin(\theta_s + \frac{2\pi}{3}) \\ \frac{1}{\sqrt{2}} & \frac{1}{\sqrt{2}} & \frac{1}{\sqrt{2}} \end{bmatrix} \quad (3)$$

The square root of the sum of  $v_d$  and  $v_q$  squares is calculated to obtain the voltage magnitude  $V$ , as follows:

$$V = \sqrt{v_d^2 + v_q^2} \quad (4)$$

This operation permits the design of a simpler control system than using  $abc$  components, by employing Proportional Integral (PI) controller, through trial and error process.

The second loop is the DC link voltage control loop that has a PI controller and it is used to regulate the DC-link capacitor voltage to a preset reference value. It would generate the reference

active current component permitting the supply of the generated FC DG active power, as shown in Fig.4.

### 2.2.2 Middle level control

The reference  $d$  and  $q$  axes currents are fed into two identical PI current controllers. The outputs of those controllers are the control voltages  $V_{inv\_d}$ , and  $V_{inv\_q}$ , which are transformed to a polar presentation, with a voltage reference amplitude and angle correction added to the reference angle, as shown in Fig.4.

### 2.2.3 Internal level control

This level is mainly composed of a line synchronization module and a three-phase three-level PWM gate pulses generator for the VSI. The line synchronization module consists mainly of a Phase Locked Loop (PLL). The PLL circuit is a feedback control system used to automatically synchronize the integrated FC/Static VAR compensator device switching pulses; through the phase  $\theta_s$  of the inverse coordinate transformation from  $dq$  to  $abc$  components, with the positive sequence components of the AC voltage vector at the PCC ( $v_q$ ). In the case of the sinusoidal PWM gate pulses generator block, the controller of the VSI generates gate pulses for the carrier-based three-phase PWM inverter using three-level topology.

## 3. Modeling of the Test System

The test distribution power system used to validate the proposed system operation and control approach is depicted in Fig. 5 as a single-line diagram.

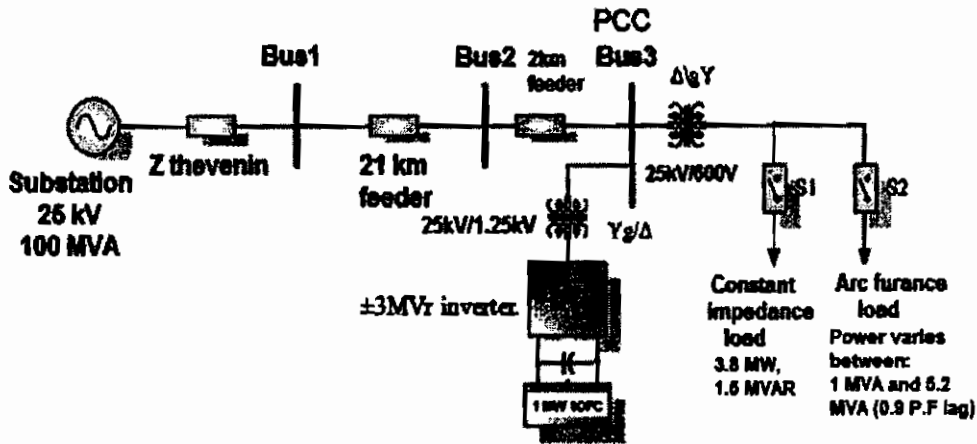

Fig.5 Single line diagram of the test system

Such a system implements a 100 MVA substation represented by a Thevenin equivalent, which feeds a distribution network operating at 25 kV/50Hz. Two feeders (21 km and 2 km) transmit power to loads connected at buses B2 and B3 or the PCC. The 600V loads are connected to bus B3 through a 25kV/600V transformer. The loads are modelled by two load types, the first is constant impedance which is the base case and the second represents a plant absorbing continuously changing currents, similar to an arc furnace. The proposed integrated FC/Static VAR compensator system is connected at PCC. This system uses a 1.25/25 kV Δ/Y (grounded) step-up coupling transformer which ensures coupling between the PWM inverter and

the distribution network. The FC system is composed of 4 modules of 250 kW SOFC, with ±3MVR inverter. The DC link capacitor is chosen to be a large value of 10000-μFarad [12]. LC damped filters are connected at the inverter output [13], [17]. The test system is built using MATLAB/SimpowerSystem blocks as shown in Fig.6. Details of the integrated FC/Static VAR compensator configuration model in MATLAB/SimpowerSystem are presented in Fig.7.

Details of the proposed controller model in MATLAB/SimpowerSystem are presented in Fig.8.

Controller parameters are presented in the Appendix.

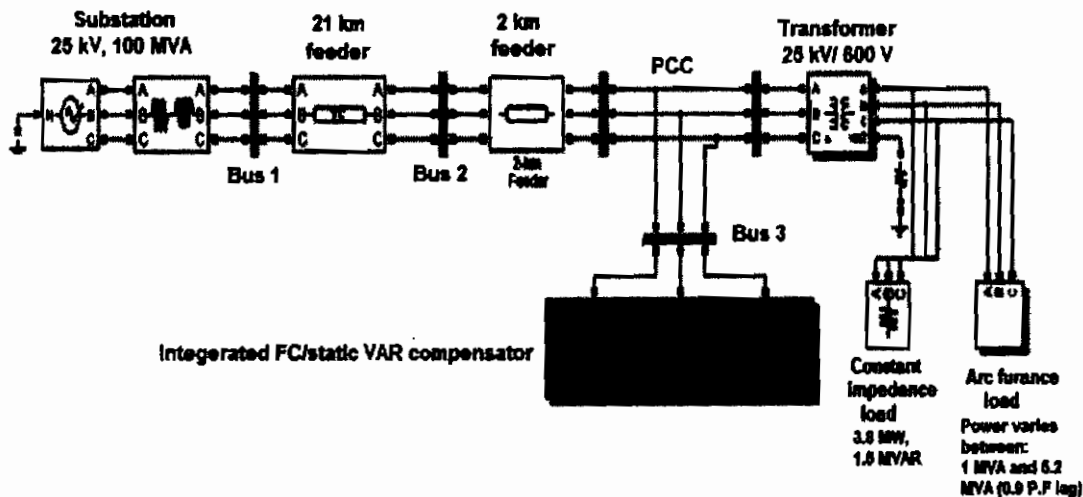

Fig.6 MATLAB model of the test system

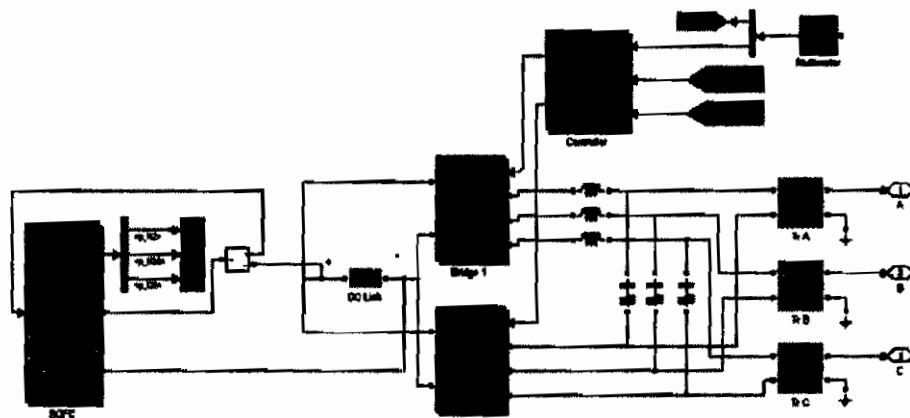

Fig.7 MATLAB model of FC/Static VAR compensator model

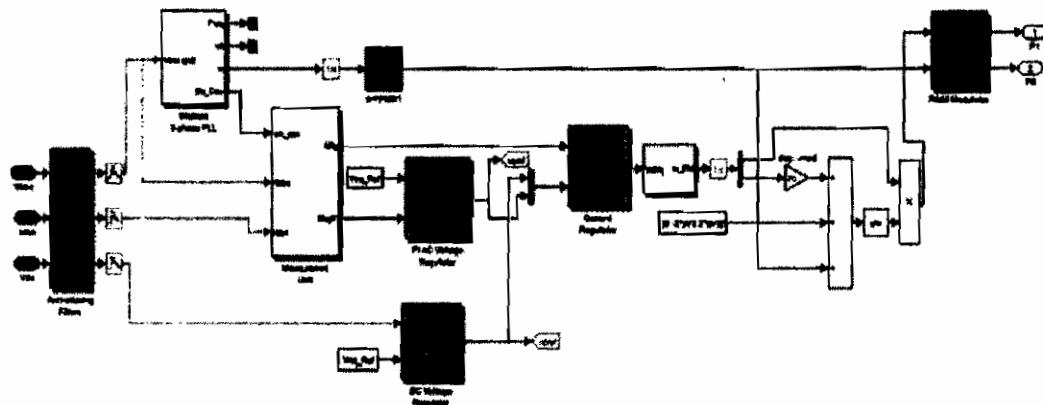

Fig.8 MATLAB model the proposed multilevel controller

#### 4. Simulation Results

Performance of the models and control schemes is thoroughly analyzed by computer simulation performed for the following cases:

- 1- Impact of FC DG connection to the distribution feeder.
- 2- Operation of FC DG in the presence of voltage sags and swells.
- 3- Operation of FC DG in the presence of voltage flicker.

##### 4.1 The Impact of FC DG Connection to the Distribution Feeder

The topology presented in the test system without the connection of the FC DG is used as a benchmark to represent the base case study. Under this scenario, the distribution utility feeds a load of 3.8 MW, and 1.5 MVAR. The voltage magnitude is measured the PCC (B3), without the

connection of the FC DG as shown in Fig.9.

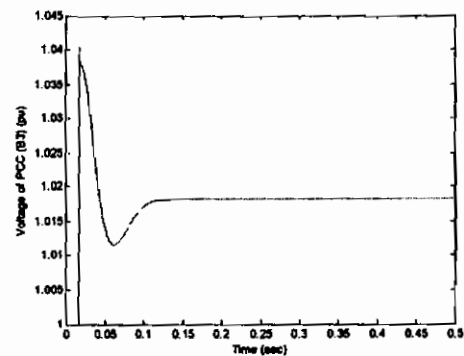

Fig.9 Voltage magnitude at B3 without FC DG connection

Now, the FC DG is connected at B3 and 1 MW power is injected. The measurement of voltage magnitude at B3 is shown in Fig.10.

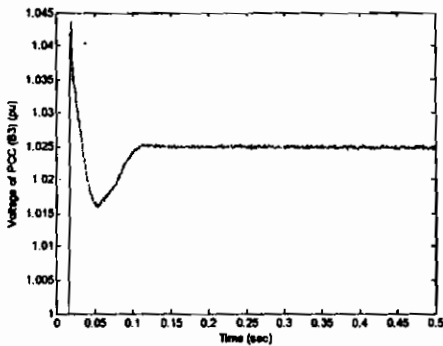

Fig. 10 Voltage magnitude at B3 with FC DG connection

The voltage increases from 1.015 pu to about 1.025 pu. When the voltage regulation capability is activated within the controller the PCC voltage is stabilized to 1.00 pu as shown in Fig. 11.

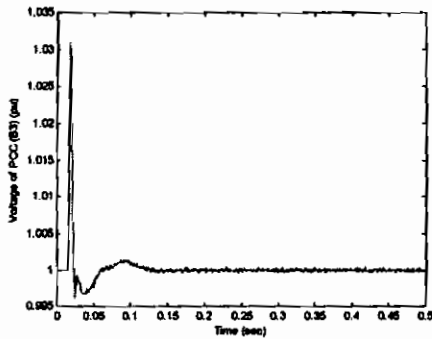
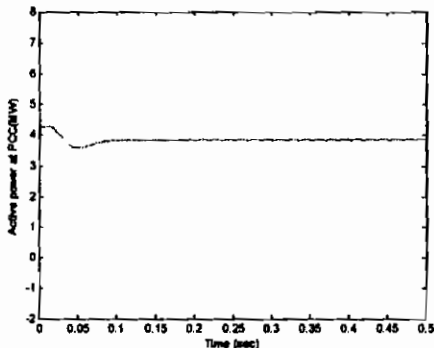
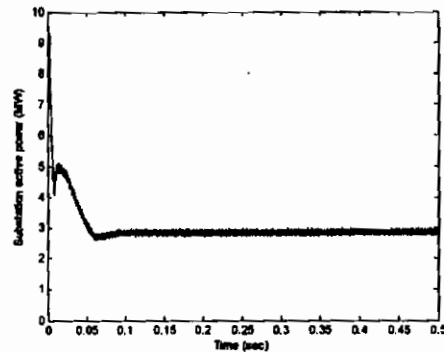

Fig. 11 Voltage magnitude at B3 with FC/Static VAR compensator

The active power at B3 absorbed from the distribution grid is shown in Fig. 12 without FC DG operation in (a), and with the FC DG (b).



(a) Without FC DG



(b) With FC DG

Fig. 12 Active power supplied from the distribution grid

Fig. 12 shows that the power is reduced to 2.8 MW due to insertion of 1MW FC DG, which validates the active power function of the controller. The DC link voltage is regulated to 2.4 kV. The load reactive power at B3 absorbed from the network is shown in Fig. 13.

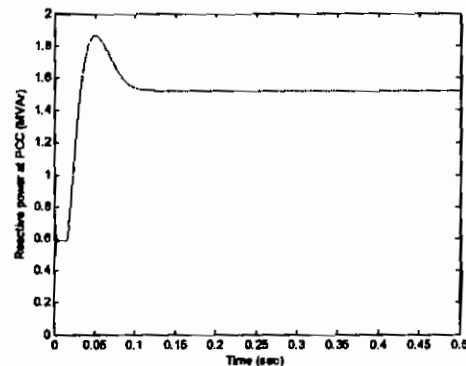

Fig. 13 Reactive power supplied from the grid without FC inverter reactive power control

When the reactive power control is activated, the controller reacts to the voltage rise by absorbing reactive power from the grid, thus increasing the overall reactive power absorbed in addition to the load, as shown in Fig. 14.



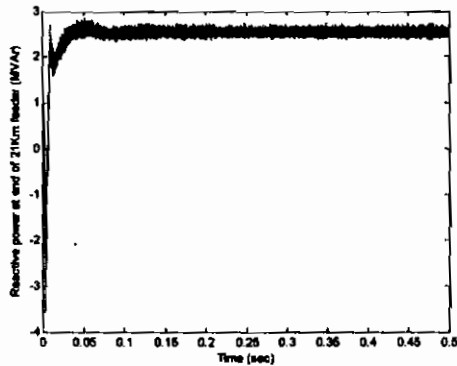
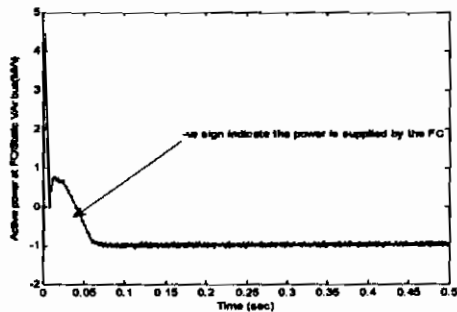
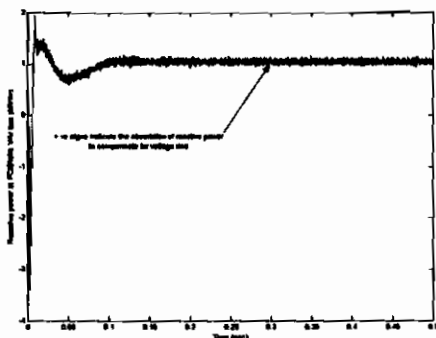

Fig.14 Reactive power supplied from the grid with FC inverter reactive power control

The integrated FC/Static VAR compensator active and reactive powers for the base case are illustrated in Fig. 15 (a) and (b).



(a)



(b)

Fig.15 Active and reactive powers of the integrated FC/Static VAR for the base case

Reactive power transfer is done through the leakage reactance of the coupling transformer by generating a secondary voltage in phase with the primary voltage (network side). This voltage is provided by a voltage-sourced PWM inverter. When the secondary voltage is lower than the bus voltage, the

integrated FC/Static VAR compensator acts like an inductance absorbing reactive power. When the secondary voltage is higher than the bus voltage, the integrated FC/Static VAR compensator acts like a capacitor generating reactive power.

**4.2 Operation of FC DG in the Presence of Voltage Sags and Swells**

Sags and swells are power frequency disturbances. These may be caused by faults or switching operations in a power system [22]. Voltage sag is defined as an RMS reduction in the AC voltage at power frequency from half of a cycle to a few seconds' duration. Voltage swell is defined as an RMS increase in AC voltage at power frequency from half of a cycle to a few seconds' duration [23]. The proposed system and its reactive power control capabilities is further tested to mitigate the voltage disturbance due to sag or swell.

To simulate the voltage sag and swell, a programmed voltage source is used to model the substation voltage with three steps at 0.2 s, 0.3 s, and 0.4 s to successively increase the substation B1 voltage by 5%, decrease it by 4% and bring it back to its initial value of 1.058 pu, as illustrated in Fig.16 without compensation. The resulted voltage at B3 is shown in Fig.17.

When the reactive power compensation is activated, the reactive power exchange by the integrated FC/Static VAR system is shown in Fig.18.

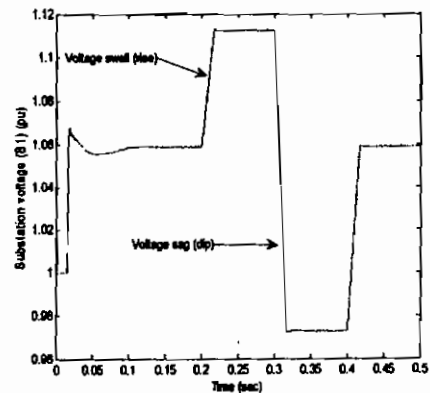

Fig.16 Voltage swell and sag at the substation bus Bus1 (pu)

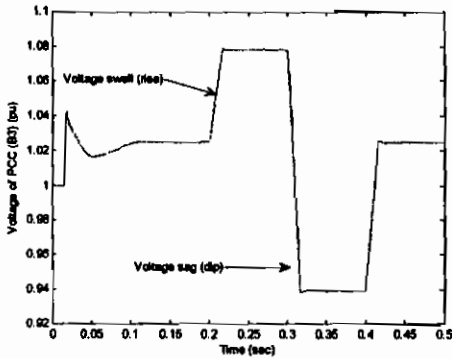

Fig. 17 Voltage swell and sag at Bus3 (pu)

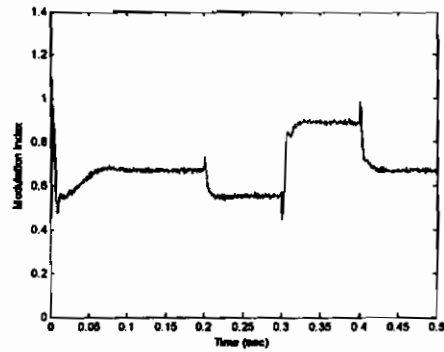

Fig. 19 Inverter modulation index during reactive power exchange

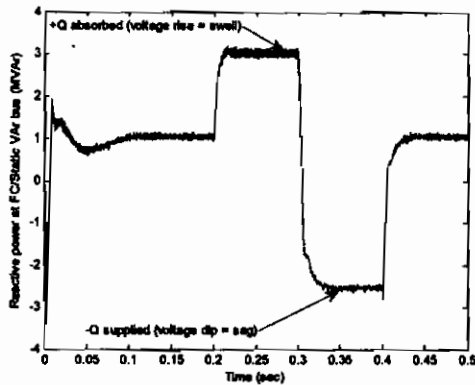

Fig. 18 Reactive power exchange of the integrated FC/Static VAR compensator

At  $t = 0.2$  s, the voltage is increased by 5%. The integrated FC/Static VAR system compensates this voltage increase by absorbing reactive power from the network ( $Q=+3$  MVAR). At  $t = 0.3$  s, the voltage is decreased by 4%. The integrated FC/Static VAR system generates reactive power to maintain the voltage at 1 pu ( $Q$  changes from +3 MVAR to -2.5 MVAR). Note that when the integrated FC/Static VAR compensator changes from inductive to capacitive operation, the modulation index of the PWM inverter is increased from 0.5 to 0.9 which corresponds to a proportional increase in inverter voltage as shown in Fig.19.

Reversing of reactive power is very fast, about one cycle, as observed from the integrated FC/Static VAR compensator current shown in Fig.20.

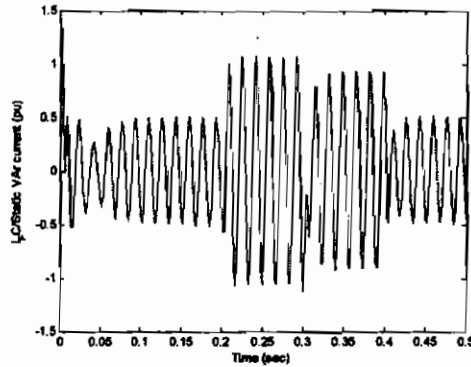

Fig.20 The integrated FC/Static VAR compensator current (pu)

The voltage profile at the PCC is improved as compared to Fig.17. The compensator regulates the voltage to 1 pu, as shown in Fig.21.

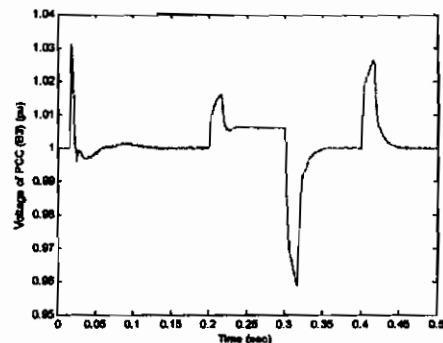

Fig.21 The regulated voltage at the PCC bus Bus3

The performance showed above validates the controller function for mitigating sags and swells. To validate the robustness of the controller for mitigating different voltage disturbances, the following section further investigates another type of voltage disturbance.

#### 4.3 Operation of FC DG in the Presence of Voltage Flicker

Voltage fluctuations are systematic variations of the voltage envelope or a series of random voltage changes, the magnitude of which does not normally exceed the voltage ranges specified by ANSI C84.1 of 0.9 to 1.1 pu [23]. Loads such as arc furnaces that can exhibit continuous, rapid variations in the load current magnitude can cause voltage variations that are often referred to as flicker. The term flicker is derived from the impact of the voltage fluctuation on lamps such that they are perceived by the human eye to flicker. To be technically correct, voltage fluctuation is an electromagnetic phenomenon while flicker is an undesirable result of the voltage fluctuation in some loads. However, the two terms are often linked together in standards. Therefore, we will also use the common term voltage flicker to describe such voltage fluctuations [23].

During simulation, a variable load current magnitude is modulated at a frequency of 5 Hz so that its apparent power varies approximately between 1 MVA and 5.2 MVA, while keeping a 0.9 lagging power factor. This load variation will allow the observation of the ability of the integrated FC/Static VAR compensator to mitigate voltage flicker. This variable load will be operating at  $t=0.15$  sec of the simulation.

The active and reactive power of the loads is measured at the PCC Bus3 as shown in Fig.22 (a) and (b) respectively.

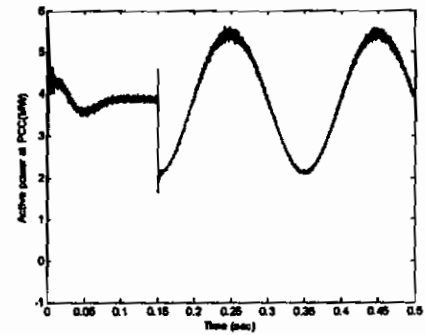

(a)

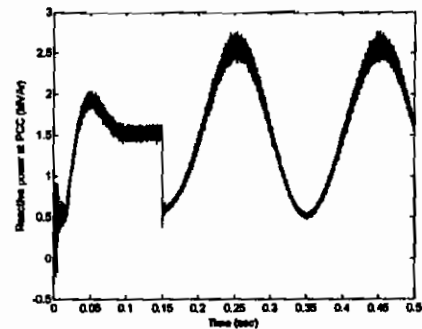

(b)

Fig.22 Active and reactive powers of the loads at the PCC bus Bus3

The voltage at the PCC Bus3 without compensation is shown in Fig.23.

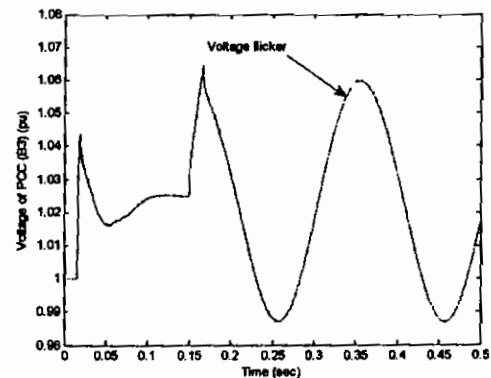

Fig.23 Voltage flicker at the PCC bus without compensation

Without reactive power compensation, B3 voltage varies between 0.99 pu and 1.06 pu from the operating voltage of 1.025 pu ( $\pm 3.5\%$  variation). With reactive power controller, simulation is restarted. The voltage fluctuation is observed at the PCC Bus3 as shown in Fig.24.

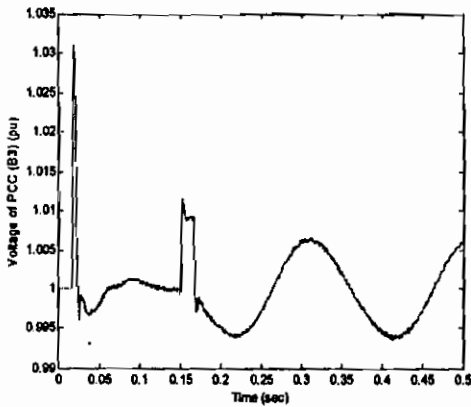

Fig.24 Voltage flicker at the PCC bus with compensation

It is observed that voltage fluctuation at the PCC Bus3 is now reduced to +/- 0.5 % of the regulated voltage of 1pu. The integrated FC/Static VAR compensator compensates voltage by injecting a reactive current ( $I_f$ ) modulated at 5 Hz and varying between 0.7 pu capacitive when voltage is low and 0.7 pu inductive when voltage is high, as shown in Fig.25.

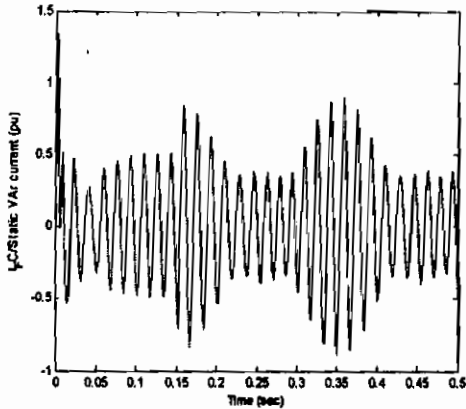

Fig.25 the integrated FC/Static VAR compensator current for the flicker case ( $I_f$ ) (pu)

### 6. Conclusions

In this paper, a proposed multi-level controller is proposed for a proposed integrated FC/Static VAR compensator. The proposed controller improve the operation of FC DG system to supply the generated active power to the network, and either generate or absorb reactive power simultaneously and independently. The control of reactive power greatly enhances

the economic and technical operation of the electric network. A Dynamic test system is built using MATLAB Simulink and Simpower system to validate the robustness of the proposed controller.

Simulation results show that the response of proposed controller is effective in mitigating the voltage rise caused by the interconnection of the DG system to the distribution feeder. Moreover, other voltage quality issues as voltage sags/swells and voltage flicker is successfully mitigated. Therefore the proposed controller adds important ancillary service to the FC DG system operation.

### 7. Appendix:

Parameters of the proposed multi-level controller

Parameter	Description	Value
$V_{dc\_ref}$	DC link reference voltage	2.4kV
$V_{ac\_ref}$	AC voltage reference	1 p.u
$K_{p\_vdc}$	DC voltage controller proportional gain	0.001
$K_{i\_vdc}$	DC voltage controller integral gain	0.15
$K_{p\_vac}$	AC voltage controller proportional gain	0.55
$K_{i\_vac}$	AC voltage controller integral gain	2500
$K_{p\_current}$	Id and Iq current controllers' proportional gain	0.8
$K_{i\_current}$	Id and Iq current controllers' integral gain	200

### 8. References

[1] F. Barbir, "PEM Fuel Cells: Theory and Practice", Elsevier Academic Press, 2005.  
 [2] Staff White Paper on: "Stationary Fuel Cells for Power Generation", Prepared Pursuant to HB 2845 (77th Legislature), Commercialization of Fuel Cells. Available at:

- www.puc.state.tx.us/electric/reports/sc  
ope/2003/app6-fuel\_cells.pdf
- [3] A.E. Hassan, M.M. El-Saadawi, K.M. Abo-Al-Ez, M.S. Kandil, "A Generalized Dynamic Model of a Fuel Cell System for DG Applications", Under publication in Mansoura Engineering Journal.
- [4] D.F. Warne, "Newnes Electrical Engineer's Handbook", Newnes, Reed Elsevier plc group, 2000.
- [5] T. Senjyu, et al, "Optimal Distribution Voltage Control and Coordination with Distributed Generation", IEEE Trans. on Power Delivery, Vol.23, 2008.
- [6] S. K. Chung, "A Phase Tracking System for Three Phase Utility Interface Inverters", IEEE Trans. Power Electron, Vol. 15, May 2000.
- [7] S. Mekhilef, T.R. Chard, V.K. Ramachandramurthy, "Voltage Rise Due to Inter-Connection of Embedded Generators", Journal of Scientific and Industrial Research, Vol.69, June 2010.
- [8] C. L. Masters, "Voltage Rise: The Big Issue When Connecting Embedded Generation to Long 11kV Overhead Lines" IEE Power Engineering Journal, Vol. 16, Feb 2002.
- [9] L.A. Kojovic, "The Impact of Dispersed Generation and Voltage Regulator Operations on Power Quality", in Proc. of CIGRE Symposium on Power Systems with Dispersed Generation, 2005.
- [10] C.M. Hird, H. Leite, N. Jenkins and H. Li, "Network Voltage Controller for Distributed Generation", IEE Transactions on Generation Transmission and Distribution. Vol. 151, March 2004.
- [11] S. Repo, H. Laaksonen, "A Case Study of Voltage Rise Problem Due to a Large Amount of Distributed Generation on a Weak Distribution Network", Proc. of IEEE PowerTech Conference, 2003.
- [12] M. Uzunoglu, O.C. Onar, "Static VAR Compensator Based Reactive Power Management for SOFC Power Plants" International Journal of Hydrogen Energy, Vol.33, 2008.
- [13] A. Hajizadeh, M. A. Golkar, "Control of Hybrid Fuel Cell/Energy Storage Distributed Generation System against Voltage Sag", Electrical Power and Energy Systems, Vol.32, issue 5, June 2010.
- [14] M. Braun, "Technological Control Capabilities of DER to Provide Future Ancillary Services", International Journal of Distributed Energy Resources, Vol. 3, no 3, 2007.
- [15] M.H. Rashid, "Power Electronics: Circuits, Devices, and Applications", Pearson: Prentice-Hall, 2004.
- [16] V. Galdi, A. Piccolo, P. Siano, "Dynamic Performances and Control of Dispersed Generators Connected through Inverter". International Conference on Computational Intelligence for Modeling, Control and Automation, Volume 1, 28-30 Nov. 2005.
- [17] G. Jóos, et al, "The Potential of Distributed Generation to Provide Ancillary Services", Proc. 2000 IEEE Power Engineering Society Summer Meeting, Vol. 3, 2000.
- [18] J. R. Macedo Jr, W. Resende, M. I. Samesima, "Shunt Tuned Filter on The LV Side of Distribution Systems: Design and Performance", IEEE (WPES) Transmission & Distribution Conference & Exposition: Latin America, 2004.
- [19] IEEE Standard: IEEE 519 – 1992.
- [20] H. Akagi, E. H. Watanabe, M. Aredes, "Instantaneous Power Theory and Applications to Power Conditioning", IEEE Press, John Wiley and sons publishers, 2007.
- [21] E. Acha, V. Agelidis, O. Anaya-Lara, and T. Miller, Power Electronic Control in Electrical System, 1<sup>st</sup> ed. United Kingdom: Newness, 2002.
- [22] C. Sankaran, "Power Quality", CRC Press, 2002.
- [23] R.C. Dugan, "Electrical Power System Quality", McGraw-Hill, 2004.