

MODIFICATION OF MECHANICAL A TRANSPLANTER TO SUIT TOPPING SUGAR BEET

EI-Khateeb, H. A.

Ag.Eng.Res.Inst., A.R.C., Dokki – Giza.

ABSTRACT

The main objectives of the present study is to construct suitable topper unit for topping sugar beet crops using the power unit of the prime mover of Yanmar ARP-8 Rice Transplanter to meet the demands of small and medium farmers in Egypt

Tests were conducted at the following topper forward speeds of 1.5, 2.0, and 2.5km/h, topping heights of 1.0, 2.0, and 3.0 (clearance between knife and feeler), and sugar beet moisture content 35.0, 42.0, and 50.0 % were used.

The results showed that by increasing the forward speed from (1.5 to 2.5 Km/h) tends to increase the over topping from (2.90 to 3.22 %), under topping (2.82 to 4.02 %), untopped (3.71 to 4.26 %), effective filed capacity (0.26 to 0.75 fed/h) slip ratio (4.0 to 7.9%) and power requirements (2.40 to 6.48 kW), and decreasing the correct topped beet from (92.00 to 90.39 %), topping efficiency from (96.29 to 95.74 %) and cost for topping operation (79.4 to 27.5 LE/fed) .The results also showed that by increasing the topping heights (clearance between knife and feeler) from (1 to 3 cm) leads to increase the topping efficiency (96.29 to 97.23 %), overtopping (2.50 to 3.22%) and decrease the under topping (4.02 to 2.60 %), and untopped beet (3.71 to 2.77 %).

INTRODUCTION

Sugar beet is one of the most important crops, not only for sugar production, but also for producing fodder and organic matter for the soil. Over 40% of the world, sugar production is produced from sugar beet. Egypt produced around one million tons of sugar beet annually. However the local consumption of sugar was about 1.5 million ton accordingly about 0.5 million ton have to be imported.(Sugar Crops Council,2010).

Accordingly, sugar beet supplying area the cultivated area of sugar beet were 248,871 feddans gave 5,138,190 sugar beet roots and 2,327,940 tons beet tops (Sugar Crops Council,2010). The importance of sugar beet is not only limited to being a supplement for sugar production, but also extend to many economical by products such as animal feed and it other secondary industries. Therefore , the government is planning to increase the growing area of sugar beet and encourage sugar beet planting in Kafr-El-Sheikh, Dakahlia, and Fayoum in addition to the newly reclaimed areas at Nobarria.

In general, removing the vegetative top portion from root crops to obtain the optimum harvested root is the ultimate goal. There are several factors that influence root crops harvesting. The most important one, is to remove the vegetative portion.

O, Dogherty (1986a) indicated that data obtained from field experiments shows large variation in under and overtopping with the total of the two sources of error ranging from 6 to 14% or more. Also, the effect of increasing the harvester speed up to 9.7km/h was studied. The result showed

an increase in overtopping with speed, together with an increase in undertopping for smaller roots, spacing.

O, Dogherty (1986 b) stated that greater precision is necessary for small beet, for example, an error of only 2.5mm can result 4% overtopping and 3.5% undertopping.

Raininko (1990) mentioned that the losses during topping operation (Fig. 1) a and b can be summarized as follows:

- 1) If the cut of topping is lower than zero level (the critical section of cutting), the loss is 1.8 t/ha, and the percentage of sugar in this part is 10.5%.
- 2) If the cut of topping is lower than zero level by 1cm, loss is 3.3 t/ha, and percentage of sugar is 16.4 %.
- 3) If the cut of topping is lower than zero level by 2cm, loss is 3.5 t/ha, and percentage of sugar is 17.2 %.

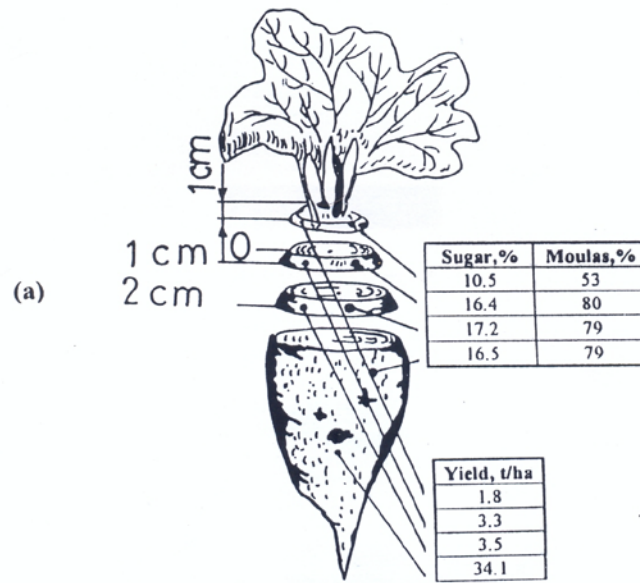

**Fig. 1: Loss of yield during topping operation (Raininko. 1990).
a) - loss caused by incorrect topping.**

Ismail *et al* (1993) developed a disc mower to remove the vegetative tops of some tuber crops. Also, increasing the knife length increased the cutting efficiency. On the other hand, the relationship between the knife edge, length, rotating speed of cutting disc and the forward speed and the height of cutting portion were formed to be not significant because of the differences in the topping height depending on the uniformity of beet height from the field surface.

El-Sherief (1996) constructed and evaluated an automatic control system to maintain relatively constant topping rates on beet over varying

field conditions. One row harvesting machine was fabricated locally for the purpose of topping and digging (lifting) sugar beet at the same time. He concluded that increasing forward speed increases cut roots, bruise roots and decreases the lifting efficiency.

Mohamed (1998) developed a topper unit to suit a small holding farms using available power tiller on farms. The percentage of topping efficiency increased from 97.04, 99.16, 100 to 100.2% by increasing forward speed from 3,4,5,and 6.2km/h, respectively. He explained that the top portion of beet (crown) needs more force to cut than the other parts of beet tuber (neck and root). The maximum needed force values to cut the beet in the upper, middle and root parts were 540, 430 and 188 N, respectively.

Abou- Shieshaa (2001) reported that the increment in forward speed and flail rotational speeds increases both broken beet and overtopping. The minimum value of overtopping and broken beet were 3.42 and 1.15%, respectively at forward speed of 1.83km/h and flail speed of 8.36m/s for mechanical planting and field chopper. Meanwhile, the percentage of undertopped was 6.35 under the same conditions.

Fathy (2004) manufactured combined machine to do all the harvesting operations of sugar beet roots (Lifting, topping and collecting). By increasing forward speed from 0.55, 0.69, 0.86 and 1.06 m/s, decreasing the topping efficiency from 97.20, 96.56, 95.77 and 94.50 %, respectively, at soil moisture content of 22.93 %. Also, increasing forward speed tends to increase the total damaged roots from 4.51,4.80,5.10 and 5.40 %, respectively.

El-Khateeb and Awad (2006) evaluate a sugar beet topping machine. The results showed that by increasing the forward speed from (1.8 to 5.0 Km/h) tends to increase the over topping from (2.50 to 3.0%), under topping (2.40 to 4.20%), untopped (2.60 to 4.0%), broken beet (6.50 to 9.90%), effective filed capacity (2..40 to 3.80 fed/h) and power requirements (14.5 to 18.0 kW).

Khallil (2007) resulted that using the constructing topper tends to decrease the labor at 75%, it is need 5-6 labor only, and saves time element reach to 300%. The total cost was decreased to 70% compared with manual harvesting.

El-Biale (2009) resulted that using developed harvester drastic reduction of 65.32% from total harvesting cost compared with manual harvesting cost. He also added that internal rate of return was 26% when using developed harvester at speed ratio 10.29.

Ibrahim, *et al.* (2010) develop a topping unit attached to potato harvester for harvesting sugar beet. They found that both forward speed and knife speed resulted in increasing overtopping, undertopping and untopped beet,%, respectively in all treatments.

Therefore, the main objectives of the present study is to construct suitable topper unit for topping sugar beet crops using the power unit of the prime mover of Yanmar ARP-8 Rice Transplanter to meet the demands of small and medium farmers in Egypt .

Two groups of experiments are to carried out in Kallin Center, El-Faramawy Farm, Kafr El Sheikh Governorate. First : Laboratory experiments

to determine the factors affecting the cutting resistance of sugar beet tubers so that the best combination may be decided upon that gives minimum cutting resistance. These factors are edge sharpness, beet area, and sugar beet moisture content. Second : Field experiments are carried out to evaluate the performance of the constructed topper unit at different machine forward speeds, different sugar beet moisture content and different topping heights (clearance between knife and feeler). Theoretical and actual field capacities, field efficiency, fuel consumption, power requirements, energy requirements, topping performance and topping cost operation (transplanter, unit topper and labor costs) product losses cost (losses price) were studied to evaluate topping performance.

MATERIALS AND METHODS

The main purpose of this research is to construct and evaluate sugar beet topper unit using the power unit of the prime mover of Yanmar ARP-8 Rice Transplanter to meet the demands of small and medium farmers in Egypt to topping sugar beet crop. On the other hand, the use of a Rice Transplanter as a source of power. However, the seedling trays of transplanter was separated and the transplanter equipped with topper unit to realizing the goal of intensification use of farm machinery. The field experiments were carried out at Kallin Center, El-Faramawy Farm, Kafr El-Sheikh, Governorate, in an area of about 1.5 feddans during the winter season of 2010.

The experimental crop of the present study was sugar beet (*Beta vulgaris* L.) variety, (Monogerm seeds), the plant number /fed 30550 plant, no. of plant/meter 4.5 plant, mean row distance 50 cm between row, root mass 950 gm, root yield 30 Mg/fed, leaves mass 20 Mg/fed and total mass 50 Mg/fed (root and leaves mass). It was planted by the mechanical seeding by American made planter type Powell (12 MX muttiflex model), mounted on tractor model Nasr 60 hp (44.77kw), diesel engine, used with seed rate of about 2.5 kg/fed. The planting speed with about 5km/h, number of row 6, empty mass 790 kg and width 430cm. Spacing between seeds, 20cm number of seeds/ cell 2 to 3 seeds, capacity of seed hopper 4 liters. The fertilizing, irrigation and spraying treats were done according to the recommendations of Agriculture Research Center.

Materials:-

The prime mover of Yanmar ARP-8 Rice Transplanter was used as a power source unit, after upon dismounting the transplanting section. The power source unit was used without any modification in forward and rotational speeds and lifting device. The topper unit was mounted on rear axle by the frame of iron.

The components of the constructed topper unit:

Topping unit:-

During developing and manufacturing the topping unit Figs.2 and3 many points were taken into consideration as the simplicity and cheapness of

the topping unit Its simple in use, easy to assembling and disassembling, the least amount of repair required and easy to adjust the topper unit.

Fabricating of machine and preliminary test were carried out at the workshop in Kallin Center, Kafr El-Sheikh, Governorate.

Frame :-

The frame is made of flat iron. Pivot made to ease the vertical movement of the feeler.

Knife :-

The straight knife was formed from flat iron (steel). It has the dimensions of 30cm long x 0.5cm thick. The knife can be easily bolted from the end on connected arm are made of hollow tube 2.5cm diameter, it can slide easily up and down leading the knife, so that, the clearance can be adjusted between the knife and the feeler.

Feeler :-

The feeler is constructed from 6 wheels with 30cm diameter which were mounted on 2.5cm diameter threaded shaft and 3cm clearance between them. The wheel is fabricated from flat iron (steel), thick 1cm was formed to be rough gear teeth shape with 0.4cm height and 0.5cm pitch of teeth. as shown in Fig.3, and fixed by welding around each wheel to avoid slippage during moving around beet top. Nuts were used to form feeler which 6 of them were used as hubs for the wheels (to keep 3cm clearance between the wheels). Feeler shaft connected rod was pulled through the machine frame by using compressing spring with 20cm length as shown in Fig.3.

Drive system :-

The machine was designed, so that, the feeler may take its motion from the ground wheel where there was an sprocket fixed in the main shaft of ground wheel and the other sprocket was fitted to the shaft of the feeler as shown in Figs.2 and3. The power is transmitted between them by using drive chine.

The modern beet harvester is fitted with a topping mechanism which, if correctly set, will satisfactorily top the beet. Fig.2 shows a typical arrangement of the drive and topping mechanism. It is important for this mechanism to be adjust correctly and there are a number of steps that can be made : Firstly, when the harvester starts work the wheels will be between rows of beet and the feeler wheel should be positioned centrally over the crown of the beet. There will be provision on the harvester to allow for lateral adjustment of the feeler wheel. Secondly, the whole feeler wheel unit, and knife, are fixed with a tension spring which allows the unit to float. Adjustment the tension of this spring gave the effect of the feeler wheel ride being heavily or lightly on the beet crop, the adjustment must be made to suit beet conditions, bearing in mind that if the beet tops are bulky the tension on the spring should be reduced so that more weight of the feeler wheel is on the top of the beet. This is necessary because the wheel helps to hold the beet in position whilst the knife cuts through the crown. The tension should be increased if the tops are light but at all times the feeler wheel must be allowed to float so that it can rise and fall to suit the various heights of the beet. Thirdly, the position of the knife in relation to the feeler wheel determines how the beet will be topped and how much crown will be removed. The knife can

be raised or lowered but its final work position will depend on the conditions of the beet. As a general guide a clearance of between knife and feeler 10 to 30 mm will be a reasonable setting to start with, see Fig.3 .

This research was divided two parts The first part was laboratory work, the second part was field work.

Methods and Measurements:

Tests were conducted at the following topper forward speeds of 1.5, 2.0, and 2.5km/h, topping heights of 1.0, 2.0, and 3.0 (clearance between knife and feeler), and sugar beet moisture content 35.0, 42.0, and 50.0 % were used.

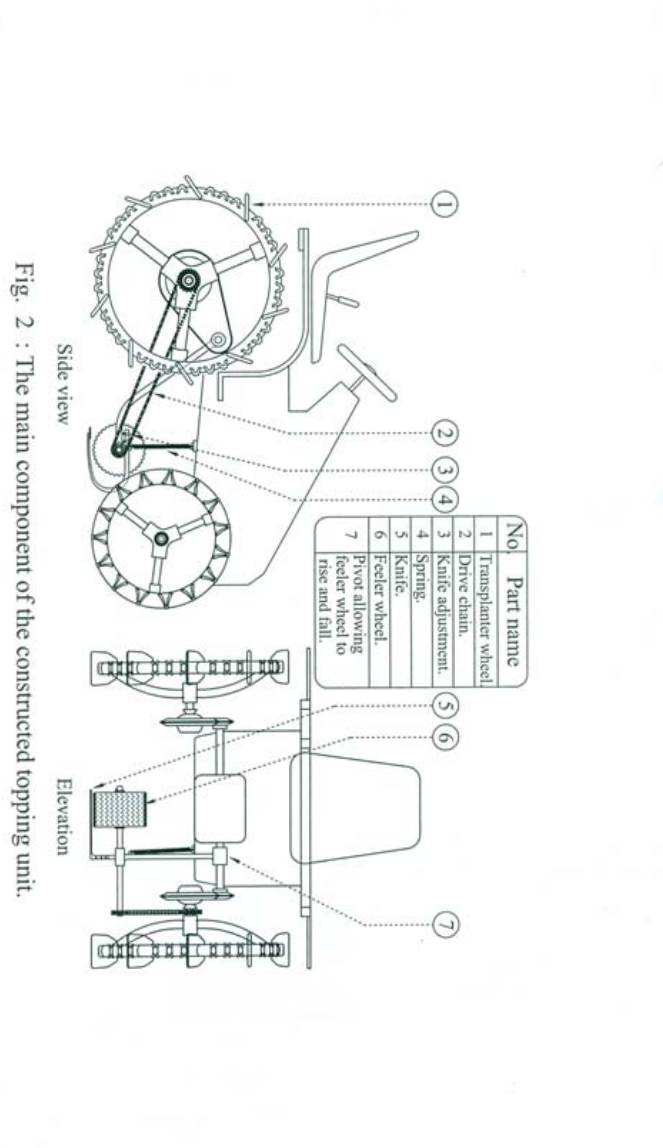

Fig. 2 : The main component of the constructed topping unit.

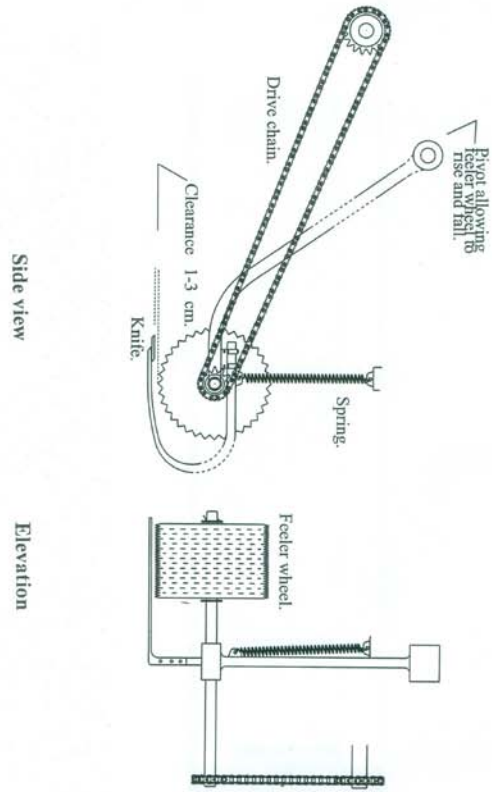

Fig.3: An elevation and side view of mechanical control system for sugar beet topping.

Measurement related to topper machine :

Topper performance:

Twenty plants of sugar beet were lifted by hand digging from every treatment and cleaned from the soil clods before harvesting operation to measure important beet properties.

During the experimental work, the performance of topping unit assessed by, lifting the beet and collecting the tops. The percentage of the items which are used to control topper performance, can be calculated by using the following equations:

$$\text{Correct topped beet (\%)} = \frac{\text{Correct topped beet}}{\text{Topped beet}} \times 100 \dots\dots\dots(1)$$

$$\text{Over topped beet (\%)} = \frac{\text{Overtopped beet}}{\text{Topped beet}} \times 100 \dots\dots\dots(2)$$

$$\text{Under topped beet (\%)} = \frac{\text{Undertopped beet}}{\text{Topped beet}} \times 100 \dots\dots\dots(3)$$

$$\text{Untopped beet (\%)} = \frac{\text{Untopped beet}}{\text{Topped beet}} \times 100 \dots\dots\dots(4)$$

$$\text{Topping efficiency (\%)} = \frac{\text{Topped beet}}{\text{Total beet}} \times 100 \dots\dots\dots(5)$$

Field capacity:

a) Theoretical field capacity (R_{th}):

Was calculated by using the following formula:

$$R_{th} = V \times W / 4.2, \text{ fed/h} \dots\dots\dots(6)$$

Where:

V = forward speed, km/h, and W = machine width, m.

b) Effective field capacity (R_{act}):

Was calculated by using the following formula:

$$R_{act} = (T)^{-1}, \text{ fed/h} \dots\dots\dots(7)$$

Where:

T = Actual time in hours required per travel, h.

c) Determination of field efficiency (η):

The field efficiency was calculated by using the following formula:

$$\eta = R_{act} / R_{th} \times 100, \% \dots\dots\dots(8)$$

Where:

R_{act} = actual field capacity, fed / h, and

R_{th} = theoretical field capacity, fed /h.

Power consumption, kW,(EP):

Estimation of the required engine power for the transplanter mounted topper unit were carried out by accurately measuring the decrease in fuel

level in the fuel apparatus. The following formula was used to estimate the engine power, (Suliman *et al.*, 1983).

$$EP = \frac{F.C \times \rho_f \times L.C.V \times 427 \times \eta_m \times \eta_{th}}{3600 \times 75 \times 1.36}, kW \quad \dots\dots\dots(9)$$

Where:

- Fc = Fuel consumption, L/h,
- l.c.v. = Lower calorific value of fuel (11030 kcal/kg for gasoline fuel),
- ρ_f = Density of the fuel (0.73 kg/l for gasoline fuel),
- 427 = Thermal-mechanical equivalent, kg.m/k cal;
- η_{th} = Thermal efficiency of engine (35% for gasoline engine), and
- η_m = Mechanical efficiency of engine (80% for gasoline engine).

Energy requirement:

Energy required for operating the topping machine was calculated according to the following equation: -

$$\text{Energy requirements} = \frac{\text{Power consumption, kw}}{\text{Actual field capacity, fed / h}}, kw.h / fed \quad \dots\dots(10)$$

Wheel topper slip percentage (S):

Wheel slip is one of the most important sources of soil and traction efficiency during machinery operation. Wheel slip changes as a function of tire conditions and wheel load soil.

$$\text{- Slip, \%} = \frac{L - L1}{L} \times 100 \quad \dots\dots\dots(11)$$

Where:

- L = Distance spent without load, m, and
- L1 = Distance spent with load, m.

Cutting resistance apparatus:

Laboratory tests to measure the cutting resistance of beet, this apparatus was built as shown in Fig.4.

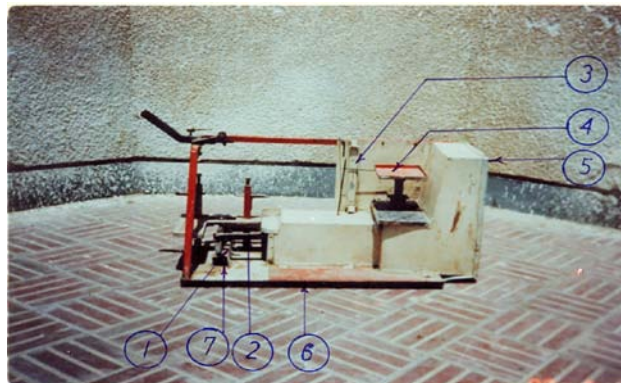

1-Knife. 2- Lever (connecting arm). 3- Ruler. 4- Weighing base.
5-Casing of the apparatus. 6- Base of the apparatus. 7- Base of cutting units.

Fig. 4: Cutting resistance apparatus

Knives were used in this study test, which were different at edge sharpness, beet area and sugar beet moisture content to find out the real factors affecting cutting resistance and the best combination of these factors which give minimum cutting resistance and the topper performance.

These factors are three edge sharpness, 0.5 , 1.0 and 1.5mm, three different beet area 0.126, 0.283, and 0.502 m² and three different sugar beet moisture content 35, 42, and 50 % were used.

Cost analysis:

Machinery costs, which include fixed cost (depreciation, interest, housing, insurance and taxes) and variable costs (repair and maintenance, fuel, oil and labor) are a major capital input for most farmers. The methodology of estimating topping costs (LE/h) or (LE/fed) was as follow (Hunt,1983).

Fixed costs:

$$- \text{Depreciation} = \frac{\text{Original cost} - \text{Salvage value}}{\text{Machinelife}} , \text{LE} / \text{year}$$

Salvage value is 10 % of original cost.

$$\text{Taxes, shelter, insurance and interest} = \frac{\text{Original cost}}{\text{Machinelife}} \times 4\% , \text{LE} / \text{h}$$

Variable costs:

$$\text{Maintenance and repair cost} = \frac{\text{Original cost}}{\text{Annual operating life}} \times 4.5\% , \text{LE} / \text{h}$$

$$\text{Labor salary} = \frac{\text{Salary}}{\text{Operating hours}} , \text{LE} / \text{h}$$

Fuel price = LE/L

Oil and lubrication = LE/L

Then:

$$\text{Total cost (LE/h)} = \text{Fixed cost (LE/h)} + \text{Variable cost (LE/h)} \dots\dots\dots(12)$$

$$\text{Total cost (LE / fed)} = \frac{\text{Total cost (LE / h)}}{\text{Effective field capacity (fed / h)}} , \text{LE} / \text{fed} \dots\dots\dots(13)$$

RESULTS AND DISCUSSION

The experiments were classified into two main parts. The first part includes developing and testing the performance of unit topper. While, the second part contained evaluating the topping accuracy of unit topper under Egyptian conditions. All experiments were conducted at Kallin Center, El-Faramawy Farm, Kafr El-Sheikh Governorate. During the winter season of 2010. In the present study, tests were conducted at the following three topper forward speeds of 1.5, 2.0, and 2.5km/h, three topping heights of 1.0, 2.0, and 3.0cm (clearance between knife and feeler) , and three sugar beet moisture content 50.0, 42.0, and 35.0 % .

Effect of edge sharpness, beet area, on cutting force and cutting resistance at different sugar beet moisture content 35,42 and 50 %.

Fig.5 and Fig 6 illustrated the cutting force as measured by the apparatus shown in Fig 4 is affected by increasing beet area. Increasing the beet area from 0.126 to 0.502 m² increased the cutting force from 480 to 720 N and decreased cutting resistance from 3.81 to 1.44 KN/m² at edge sharpness of 0.5mm and sugar beet moisture content of 35 %.The decrease in cutting force and cutting resistance at high moisture content is due to the viability of the tissues of sugar beet.

Also, by increasing the edge sharpness from (0.5, 1.0 and 1.5mm), increased the cutting resistance from (3.81, 4.45, and 5.49 KN/m²), and cutting force from (480, 560, and 691 N), respectively. at sugar beet moisture content of 35 % and beet area 0.126 m². Generally, the cutting force and cutting resistance is a directly proportionally with the edge sharpness.

Machine performance:

Topping operation:

Values of topping efficiency, under topped, correct topped, over topped, and untopped beet were calculated.

Overtopping:

Fig.7 illustrate the effect of forward speed, sugar beet moisture content and topping heights on overtopping %. It can be noticed that increasing the forward speed from 1.5 to 2.5 km/h tends to increase overtopping percentage from 2.9 to 3.22 % at sugar beet moisture content of 50.0% and topping height 3cm, respectively. These trends may be due to the difficulty of keeping topping knife adjusted at a constant height during high speeds.

In the same manner, the same increment of the topping heights from 1 to 3cm tends to increase overtopping from 2.50 to 3.22 % at forward speed of 2.5km/h and sugar beet moisture content of 50.0%, respectively. Similar results have been obtained by El-Khateeb and Awad, 2006.

Undertopping:

Fig.8 show the effect of forward speed, sugar beet moisture content and topping heights on undertopping %. It can be said that increasing the forward speed from 1.5 to 2.5km/h tends to increase undertopping beet percentage from 2.82 to 4.02 % at sugar beet moisture content of 50.0% and topping height 1cm, respectively. These trends may be due to the difficulty of keeping topping knife adjusted at a constant height during high speeds.

Meanwhile, the same increment of the topping heights from 1 to 3cm tends to decrease undertopping beet from 4.02 to 2.60% at forward speed of 2.5km/h and sugar beet moisture content of 50.0%, respectively.

This results due to small value of topping heights gives more accumulation and big value of topping heights gives less chance of accumulation. Accumulation, push the feeler upward which let the feeler make false sensing guiding the knife always to undertopped results Mohamed, 1998.

Untopped beet

Fig.9 illustrate the effect of forward speed, sugar beet moisture content and topping heights on untopped beet %. They indicated that by increasing the forward speed from 1.5 to 2.5 km/h tends to increase untopped

beet percentage from 3.71 to 4.26 % at sugar beet moisture content of 50.0% and topping height 1cm, respectively.

On the other hand, the same increment of the topping heights from 1 to 3cm tends to decrease untopped beet from 3.71 to 2.77% at forward speed of 1.5km/h and sugar beet moisture content of 50.0%, respectively. This results may be due to eliminate the accumulation by increasing the topping heights. Similar results have been obtained by Mohamed, 1998 and El-Biale, 2009.

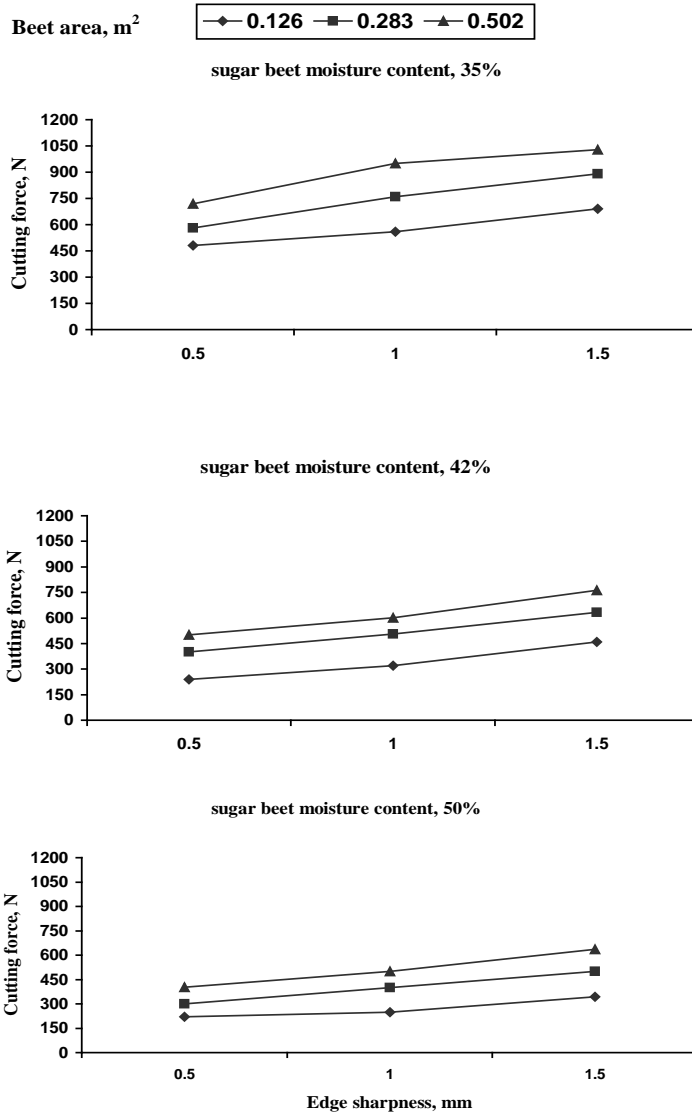

Fig.5: Effect of edge sharpness and beet area on cutting force at different sugar beet moisture content.

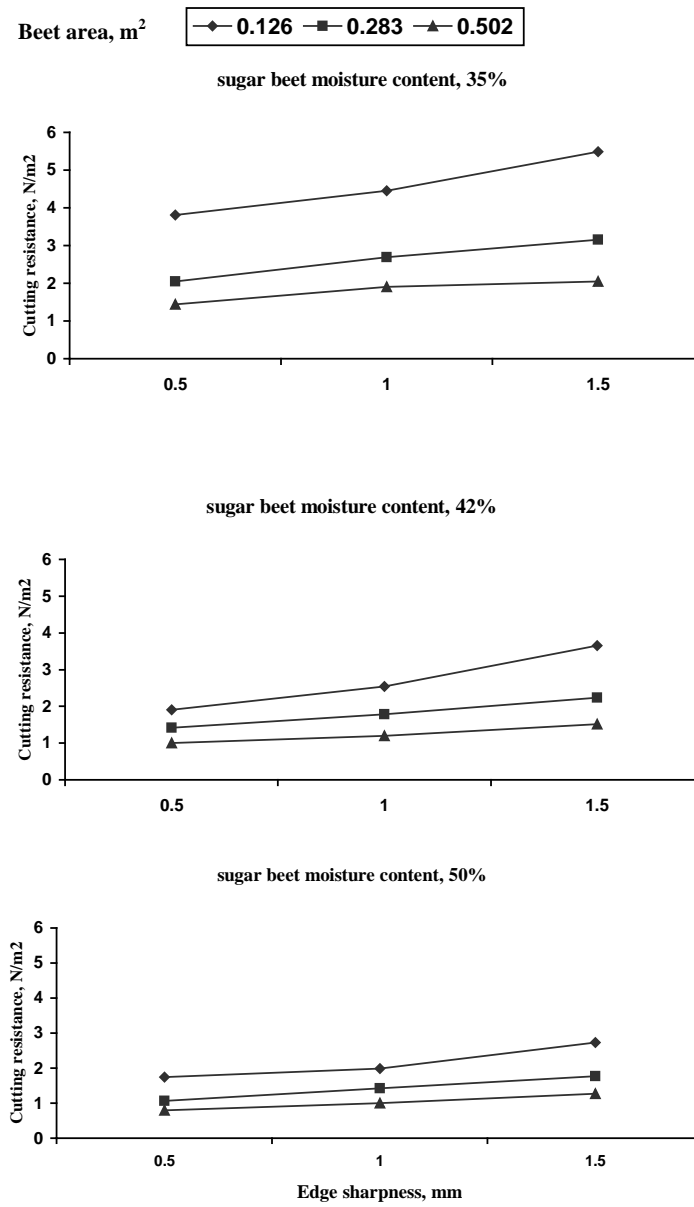

Fig.6: Effect of edge sharpness and beet area on cutting resistance at different sugar beet moisture content.

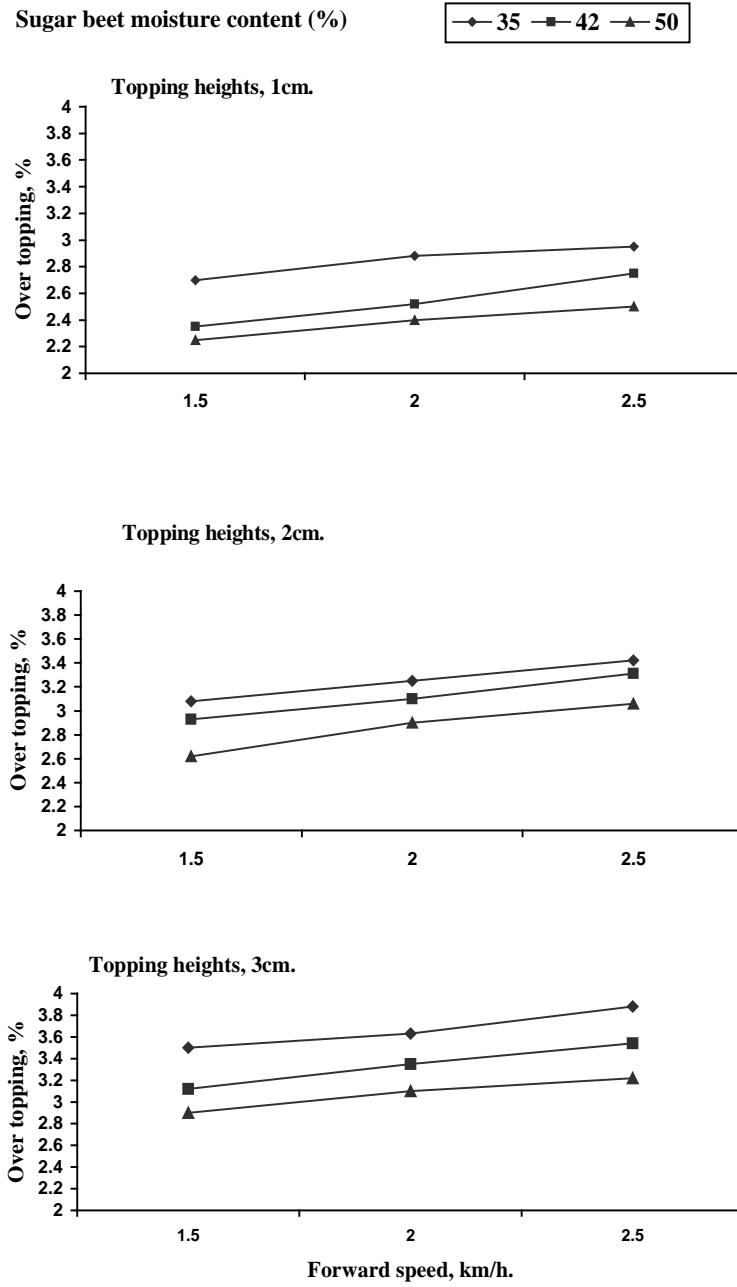

Fig.7: Effect of forward speed and sugar beet moisture content on over topping beet percentage at topping heights 1,2 and 3 cm.

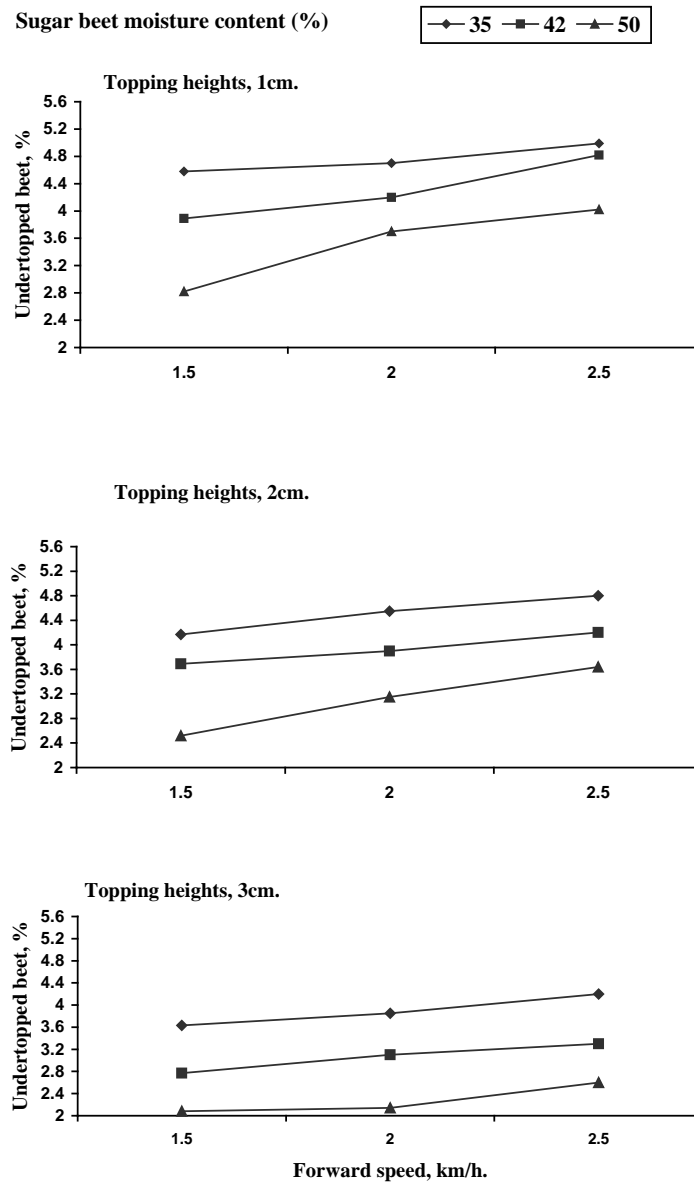

Fig.8.: Effect of forward speed and sugar beet moisture content on Undertopped beet percentage at topping heights 1,2 and 3 cm.

10

511

Correct topped beet:

Fig.10 illustrate the effect of forward speed, sugar beet moisture content and topping heights on correct topped beet %. It can be noticed that increasing the forward speed from 1.5 to 2.5km/h tends to decrease correct topped beet percentage from 92.00 to 90.39 % at sugar beet moisture content of 35.0% and topping height 3cm, respectively. These trends may be due to the difficulty of keeping topping knife adjusted at a constant height during high speeds.

Meanwhile, the topping height of 2 cm recorded the highest values correct topped beet percentage which were 95.91, 95.00 and 93.50% at forward speed of 1.5km/h, followed topping height 1, and 3 cm, respectively. Similar results have been obtained by Abd El-Raouf,2002 and El-Biale, 2009.

Topping efficiency:

The percentage of topping efficiency is related to the percentage of untopped beet, which the percentage of untopped beet increased by increased the forward speed. The percentage of topping efficiency decreased by increasing the forward speed.

Fig.11 summarize the effect of forward speed, sugar beet moisture content and topping heights on topping efficiency %. It could be realized that increasing the forward speed from 1.5 to 2.5 km/h tends to decrease the topping efficiency percentage from 96.29 to 95.74 % at sugar beet moisture content of 50.0% and topping height 1cm, respectively.

On the other hand, by increasing of the topping heights from 1 to 3cm tends to increase topping efficiency from 96.29 to 97.23 % at forward speed of 1.5km/h and sugar beet moisture content of 50.0%, respectively. Similar results have been obtained by Fathy,2004 and El-Biale, 2009.

The maximum topping efficiency of 97.23% was recorded at topping height 3cm, sugar beet moisture content of 50.0% and forward speed of 1.5km/h. The minimum topping efficiency of 95.01% was recorded at topping height 1cm, sugar beet moisture content of 35.0% and forward speed of 2.5km/h.

Field capacity and efficiency:

During test operation in the field, the distance was constant, so the main effect factor to measure the field capacity was the time.

By increasing the forward speed, increase the theoretical and actual field capacity. As shown in Table 1. At this Table, by increasing forward speed from 1.5 to 2.5 km/h tends to increase the theoretical field capacity from 0.4 to 0.86 fed/h, and actual field capacity from 0.26 to 0.75 fed/h. Generally, the field capacity is directly proportional to forward speed. Also, by increasing the forward speed, increase the field efficiency. This results due to increase the forward speed decrease the effective time and increasing the actual field capacity.

Table 1: The relationship between forward speed, theoretical field capacity, actual field capacity, field efficiency and slip ratio at topping height 3 cm and sugar beet moisture content of 50%.

Forward speed, km/h	1.5	2.0	2.0
Theoretical field capacity, fed/h	0.4	0.53	0.88
Actual field capacity, fed/h	0.26	0.45	0.75
Field efficiency, %	65.00	84.91	87.21
Topping efficiency, %	97.23	97.10	96.80
Slip ratio, %	4.0	5.5	7.9

By increasing the forward speed from 1.5 to 2.5km/h, the field efficiency increased from 65 to 87.21 %. Generally, the field capacity is directly proportional to forward speed. This agrees well with (Kamel and El-Khateeb, 2002).

Slip ratio, (%):

By increasing topper machine forward speed from 1.5 to 2.5 km/h tends to increased the slip from 4.0 to 7.9 % as shown in Table 1. This is due to increase of the soil resistance.

Fuel consumption:

Table 2 illustrated the effect of forward speed on fuel consumption lit/h.. The fuel consumption was measured in two cases of the machine, the machine without and with load in the field.

Machine fuel consumption increased by increasing forward speed as shown in Table 2. By increasing the forward speed from 1.5 to 2.5km/h tends to increase the fuel consumption with load from 0.76 to 2.05 lit/h. and the machine fuel consumption without load increased from 0.3 to 0.7 lit/h. This results due to increase the forward speed, increase the resistance against the machine which it meets a lot of beet tubers in short time. Generally, topper machine fuel consumption is directly proportional to forward speed.

Energy required:

Table 2 clearly indicates the decrease of total energy required kW.h/fed by increasing forward speed. This results due to decrease the affective time and increase the actual field capacity.

By increasing the forward speed from 1.5 to 2.5 km/h tends to decrease energy required from 9.24 to 8.62 kW.h/fed.

The maximum value of energy required was 9.24kW.h/fed at forward speed 1.5km/h, and minimum energy required were 8.26 kW.h/fed at forward speed 2.5 km/h. Generally, energy required is inversely proportionally to forward speed.

Table2: The relationship between forward speed, fuel consumption, power consumed and energy requirement.

Forward speed, km/h	1.5	2.0	2.5
Fuel consumption, l/h			
with load	0.76	1.30	2.05
Without load	0.3	0.5	0.7
power required, kW	2.40	4.11	6.48
Actual field capacity, fed/h	0.26	0.45	0.75
Energy requirements, kW.h/fed	9.24	9.12	8.62

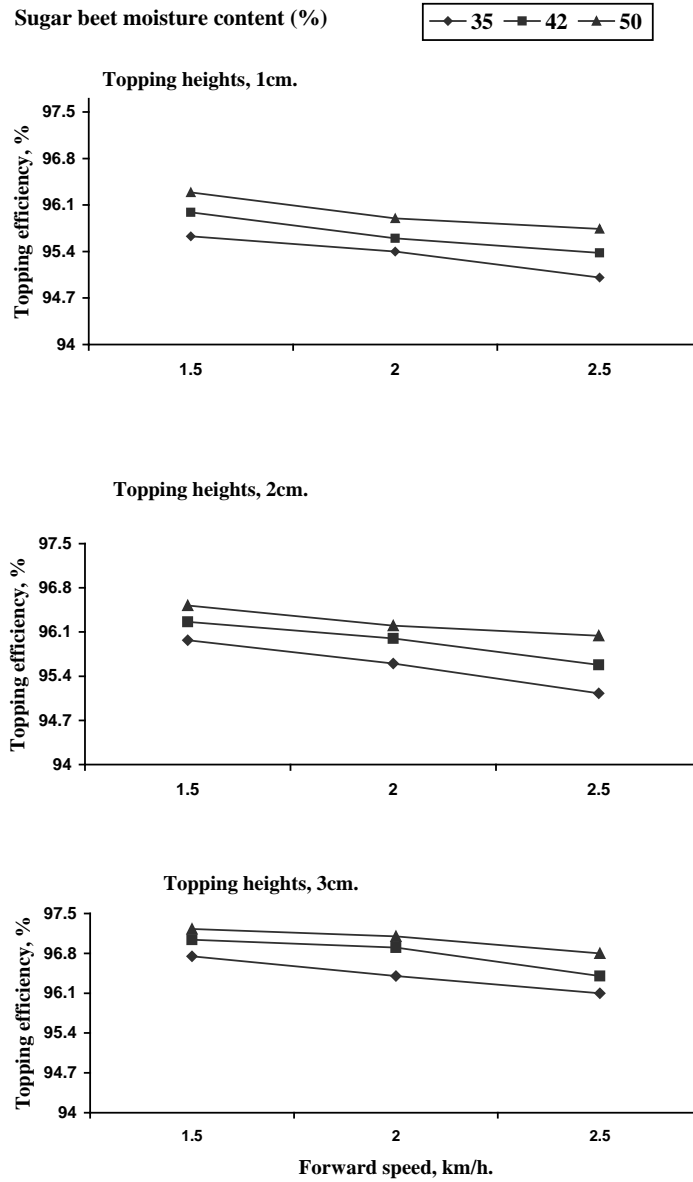

Fig.11: Effect of forward speed and sugar beet moisture content on Topping efficiency percentage at topping heights 1,2 and 3 cm.

Cost of topping operation:

By the economic of view the use of any machine usually depends on machine purchase price, labor charges and working capacity of machine. Among these factors, machine purchase price varies with passage of the time

and is an unpredictable factor, especially when it is imported. By keeping in view these factors the economics of mechanism under study was evaluated .

The results indicated that the total costs for (Transplanter and topper unit) were 20.65 LE/h. While the total costs for topping operation was 79.4, 45.9 and 27.5 LE/fed, at topping forward speeds 1.5, 2.0 and 2.5 km/h, respectively.

Cost of manual topping:

For topping and loading one feddan, 15 labors are used and each labor takes 15 LE, so the manual cost of topping and loading one feddan is 225 LE/fed. This result reflects that mechanical topping causes a drastic reduction at topping operation cost.

CONCLUSION

From the above results the following conclusion are derived:

- 1- The increasing the forward speed from 1.5 to 2.5 km/h tends to increase undertopping beet percentage from 2.82 to 4.02 % at sugar beet moisture content of 50.0% and topping height 1cm.
- 2- The increment in forward speed from 1.5 to 2.5km/h tends to decrease correct topped beet percentage from 92.00 to 90.39 % at sugar beet moisture content of 35.0% and topping height 3cm.
- 3- The maximum topping efficiency of 97.23% was recorded at topping height 3cm, sugar beet moisture content of 50.0% and forward speed of 1.5km/h. The minimum topping efficiency of 95.01% was recorded at topping height 1cm, sugar beet moisture content of 35.0% and forward speed of 2.5km/h.
- 4- The maximum value of energy required was 9.24kW.h/fed at forward speed 1.5km/h, and minimum energy required were 8.26 kW.h/fed at forward speed 2.5km/h.
- 5- The unit cost was reached 79.4, 45.9 and 27.5 LE/fed, when the topping forward speeds increased from 1.5, 2.0 and 2.5 km/h. Also, the manual topping cost reached about 225 LE/fed.

REFERENCES

- Abd El-Raouf, M.A. (2002). Development of small machine suitable for harvest sugar beet under Egyptian conditions. Ph.D. Thesis, Agric Eng. Dept., Fac. of Agric., Tanta Univ. Egypt.
- Abou-Shieshaa, R.R. (2001). A study on mechanical topping of sugar beet under Egyptian conditions. *Misr J. Ag. Eng.*, 18 (3): 569 – 584.
- El-Biale, N.M.Y. (2009). Development of sugar beet harvester to suit Egyptian condition. Ph.D.Thesis, Agric. Mech.Dept., Fac. of Agric. Al-Azhar univ. Cairo.
- El-Khateeb, H.A and N.M. Awad (2006). The mechanical performance of sugar beet topper. *Egypt J. Agric. Res.*, 84 (1) : 111-128.
- El-Sherief, R.R.(1996). A study on harvesting mechanization of sugar beet. Ph.D. Thesis, Agric. Mech. Dept., Fac.of Agric. Kafr El-Sheikh, Tanta Univ., Egypt.

- Fathy, A.M. (2004). Manufacturing a small machine to suit harvesting sugar beet under Egyptian conditions. Ph.D. Thesis, Fac. of Agric., Agric. Mech. Dept., Kafr El-Sheikh, Tanta Univ., Egypt.
- Hunt, D.R. (1983). Farm power and machinery management. Iowa state univ. Press AMES, Iowa, U.S.A.
- Ibrahim, M.M.; H.N. Abdel-Mageed and A.E. Khater (2010). Factors affecting on topping efficiency and quality of sugar beet crop. The 5th Arab Mansoura Conference of Food and Dairy Science & Technology 18-22 October 2010. Mansoura Univ. J. of Agric. Sci., 35 (8) : 810-825.
- Ismail, Z.E.; Y.M. El-Hadidy and M.A. El-Saadany (1993). The utilization of a developed disk mower to remove vegetative tops of some tuber crops. Misr J. Ag. Eng., 11 (2): 401-424.
- Kamel, O. and El-Khateeb, H.A. (2002). Performance evaluation of two different system of rice transplanter under Egyptian conditions. Egypt J. Agric. Res., 80 (3) : 1317-1335.
- Khalil, A. (2007). Design and construction of sugar beet harvesting machine suitable for Egyptian condition. M.Sc. Thesis. Production Eng. and Mechanical Design. Dept. Fac. of Eng. Tanta Univ.: 39-129.
- Mohamed, A.H.A. (1998). Design and development of a sugar beet topper. Ph.D. Thesis, Fac. of Agric. Agric Mech. Dept., Ain-Shams Univ.
- O, Dogherty, M.J. (1986 a). The design of feeler wheel toppers for sugar beet (Topper dynamics). J. Agric. Eng. Res., 34 : 305-318.
- O, Dogherty, M.J. (1986 b). The design of feeler wheel toppers for sugar beet (Topper geometry). J. Agric. Eng. Res., 34 : 333- 341.
- Raininko, K. (1990). Sweden sugar beet production. J. of Sugar, 1 (29): 32-62.
- Sugar Crops Council., (2010). Report on sugar crops and sugar production in Egypt. The Central Council for Sugar Crops. (In Arabic). Ministry of Agric. and Land Reclamation: 18.
- Suliman, A.E.; G.E. Nasr and W.M. Awady (1993). A study on the effect of different systems of tillage on physical properties of the soil.. Misr J. Ag. Eng., 10 (2): 169-189.

تعديل ميكانيكي في الشتالة ليناسب تطويش أوراق بنجر السكر حمادة على الخطيب

معهد بحوث الهندسة الزراعية – دقي – جيزة- مصر

المساحة الكلية المنزرعة من محصول بنجر السكر في مصر حتى عام 2010م بلغت حوالي (248871 فدان) من بنجر السكر منهم (5138190 طن) جذور بنجر السكر و(2327940 طن) من عرش بنجر السكر ومتوسط إنتاجية الفدان (30طن/فدان) 0

تهدف هذه الدراسة إلى انشاء وتطوير وحدة تطويش عرش بنجر السكر مركبة على أكس العجل الخلفي للشتالة لتناسب الحيازات الصغيرة وذلك باستخدام قدرة الجر الصغيرة المتوفرة لهذه الحيازات وهي شتالة الأرز اليابانية وكان الهدف من هذه الدراسة هو تحويل شتالة الأرز لآلة متعددة الاستخدام بورشة مركز قلين محافظة كفر الشيخ بدلا من استخدامها في شتل الأرز فقط وبالتالي تزداد أهمية هذه الشتالات باستخدامها على مدار العام وبالتالي تصبح أكثر اقتصاديا ويراعى في تصنيع الوحدة إن التصنيع يتم باستخدام خامات محلية متوفرة بالسوق المحلي بحيث تمكن الورش المحلية من تصنيعها وصيانتها0

وقد تم إجراء نوعين من الاختبارات هما:

١ - اختبارات معملية:

تم إجراء اختبارات معملية لدراسة العوامل المؤثرة في مقاومة القطع لدرنات بنجر السكر وإيجاد أفضل توليفة من العوامل التالية بحيث تقلل من قيمة مقاومة القطع والعوامل هي:

- حديدية حافة السلاح (0 و5 - 1 - 1 و5 مم).
- مساحة عرش البنجر (0 و126 - 0 و283 - 0 و502 مم).
- المحتوى الرطوبي للبنجر (35 - 42 - 50 %).

٢ - اختبارات حقليّة:

تمت التجارب الحقليّة بمزرعة الفرماوى التابعة لمركز قلين - محافظة كفر الشيخ 0

ولقد اشتملت الدراسة على المتغيرات التالية:-

- أ- السرعة الأمامية للآلة (1 و5 - 2 و0 - 2 و5 كم/ ساعة).
- ب- المحتوى الرطوبي لعرش البنجر (35 - 42 - 50 %).
- ج- الخلوص بين السكينة وعجلة المجس (1 - 2 - 3 سم).

يمكن تلخيص النتائج المتحصل عليها :-

قيمه مقاومه القطع قيست بواسطة جهاز قياس قوه القطع ووجد ان :

- 1- بزيادة مساحة عرش البنجر من 0 و126 إلى 0 و502 مم عند محتويات رطوبة 35 - 42 - 50 % زادت قوة القطع من (220 إلى 402 نيوتن) - (240 إلى 500 نيوتن) - (480 إلى 720 نيوتن) على التوالي 0
- 2- أيضا عندما زاد المحتوى الرطوبي من 35 إلى 50 % أدى إلى نقص قوة القطع من 720 إلى 402 نيوتن عند مساحة عرش البنجر 0 و502 مم 0
- 3- زيادة حديدية حافة السكينة من 5 إلى 1 و5 مم أدى إلى زيادة قوة القطع من 402 إلى 635 نيوتن عند مساحة عرش البنجر 0 و502 مم 0
- ٤ - قيمة مقاومة القطع (كيلو نيوتن / 2م) أخذت نفس اتجاه قوة القطع عند معاملات السابق ذكرها وهي المحتوى الرطوبي وحديدية حافة السلاح 0
- ٥ - بزيادة مساحة عرش البنجر من 0 و126 إلى 0 و502 مم عند محتويات رطوبة 35 - 42 - 50 % قلت مقاومة القطع من (1 و75 إلى 0 و80 كيلو نيوتن / 2م) - (1 و91 إلى 1 و0 كيلو نيوتن / 2م) - (3 و81 إلى 1 و44 كيلو نيوتن / 2م) على التوالي 0

التطويش الجائر (%):

- 1- بزيادة السرعة الأمامية لآلة التطويش من 1 و5 إلى 2 و5 كم/ساعة أدى إلى زيادة النسبة المئوية للتطويش الجائر من 2 و90 إلى 3 و22 % عند محتوى رطوبي لعرش بنجر السكر 50 % وارتفاع سكينه التطويش عن عجلة المجس 1 سم على التوالي 0
- 2- بزيادة ارتفاع سكينه التطويش عن عجلة المجس من 1 إلى 3 سم أدى ذلك إلى زيادة التطويش الجائر من 2 و50 إلى 3 و22 % عند سرعة أمامية للآلة 2 و5 كم/ساعة محتوى رطوبي لعرش بنجر السكر 50 % على التوالي 0

التطويش السطحي (%):

- 1- بزيادة السرعة الأمامية لآلة التطويش من 1 و5 إلى 2 و5 كم/ساعة أدى إلى زيادة النسبة المئوية للتطويش السطحي من 2 و82 إلى 4 و02 % عند محتوى رطوبي لعرش بنجر السكر 50 % وارتفاع سكينه التطويش عن عجلة المجس 1 سم على التوالي 0
- 2- بزيادة ارتفاع سكينه التطويش عن عجلة المجس من 1 إلى 3 سم أدى ذلك إلى نقص التطويش السطحي من 4 و02 إلى 2 و60 % عند سرعة أمامية للآلة 2 و5 كم/ساعة محتوى رطوبي لعرش بنجر السكر 50 % على التوالي 0

عرش البنجر غير المطوش (%):

- 1- بزيادة السرعة الأمامية لآلة التطويش من 1 و5 إلى 2 و5 كم/ساعة أدى إلى زيادة النسبة المئوية لعرش البنجر غير المطوش من 3 و71 إلى 4 و26 % عند محتوى رطوبي لعرش بنجر السكر 50 % وارتفاع سكينه التطويش عن عجلة المجس 1 سم على التوالي 0
- 2- بزيادة ارتفاع سكينه التطويش عن سطح البنجر من 1 إلى 3 سم أدى ذلك إلى نقص النسبة المئوية لعرش البنجر غير المطوش من 3 و71 إلى 2 و77 % عند سرعة أمامية للآلة 1 و5 كم/ساعة محتوى رطوبي لعرش بنجر السكر 50 % على التوالي 0

التطويش الصحيح (%):

1- بزيادة السرعة الأمامية لآلة التطويش من 1 و5 إلى 2 و5 كم/ساعة أدى إلى نقص النسبة المئوية للتطويش الصحيح لعرش البنجر من 92 و00 إلى 90 و39 % عند محتوى رطوبي لعرش بنجر السكر 35% وارتفاع سكينه التطويش عن عجلة المجس 3 سم على التوالي0

2- قيمة ارتفاع سكينه التطويش عن عجلة المجس 2 سم سجلت اعلي قيم للتطويش الصحيح لعرش البنجر 95 و91 – 95 و00 – 93 و50 % عند سرعة أمامية للآلة 1 و5 كم/ساعة 0 يلي ذلك ارتفاع سكينه التطويش عن عجلة المجس 1 سم ثم ارتفاع سكينه التطويش عن عجلة المجس 3 سم على التوالي 0

كفاءة التطويش (%):

1- بزيادة السرعة الأمامية لآلة التطويش من 1 و5 إلى 2 و5 كم/ساعة أدى إلى نقص النسبة المئوية لكفاءة التطويش لعرش البنجر 96 و29 إلى 95 و74 % عند محتوى رطوبي لعرش بنجر السكر 50% وارتفاع سكينه التطويش عن عجلة المجس 1 سم على التوالي0

2- زيادة ارتفاع سكينه التطويش عن عجلة المجس من 1 إلى 3 سم أدى ذلك إلى زيادة النسبة المئوية لكفاءة التطويش لعرش البنجر من 96 و29 إلى 97 و23 % عند سرعة أمامية للآلة 1 و5 كم/ساعة محتوى رطوبي لعرش بنجر السكر 50% على التوالي0

السعه الفعلية والكفاءة الحقلية :

* بزيادة السرعة الأمامية للآلة من 1 و5 إلى 2 و5 كم/ساعة أدى ذلك إلى زيادة السعه الفعلية من 26 و إلى 75 و فدان/ساعة0 أيضا زادت الكفاءة الحقلية من 65 إلى 87 و21 %0

استهلاك الوقود والطاقة المستهلكة :

* بزيادة السرعة الأمامية للآلة من 1 و5 إلى 2 و5 كم/ساعة أدى ذلك إلى زيادة استهلاك الوقود من 76 و إلى 05 و2 لتر/ساعة0 ونقصت الطاقة المستهلكة من 9 و24 إلى 8 و62 كيلووات/ساعة/فدان0

تكاليف عملية التطويش :

* تكاليف عملية التطويش كانت (4 و79 – 9 و45 – 5 و27 جنية/ فدان) وذلك عند سرعة أمامية (5 و1 – 2 و5 كم/ساعة) مقارنة بالتكاليف اليدوية كانت 225 جنية/ فدان0 بالتالي فان تكاليف عملية التطويش الميكانيكي سببت تخفيض شديد من تكاليف التطويش اليدوي0

أنسب ظروف تشغيل للإله المطورة:-

1 - أعطت الآلة المطورة اقل قيم للتطويش الجائر والتطويش السطحي والمتروك بدون تطويش واقل تكاليف تطويش وذلك عند سرعة أمامية للآلة 1 و5 كم/ساعة محتوى رطوبي لبنجر السكر 50% الخلوص بين السكينه وعجلة المجس 3 سم (2 و25 – 1 و98 – 2 و77 % – 4 و79 جنية/ فدان) على التوالي0

2 - عند نفس الظروف السابق ذكرها أعطت اعلي قيم للتطويش الصح وكفاءة تطويش كالتالي (91 و95 – 23 و97 %) على التوالي0

الأضافه العلمية الجديدة :-

- استخدام مصدر قدرة شتالة الأرز كمصدر قدرة لتشغيل وحدة التطويش حيث يعمل على زيادة عدد ساعات التشغيل الكلية وبالتالي تخفيض تكاليف عملية التطويش فضلا عن العمليات الأخرى التي تقوم بها الشتالون
- تصنيع وحدة تطويش ملحقة بمصدر القدرة للشتالة وعمل التعديلات اللازمة على مصدر القدرة لتناسب إزالة العرش الأخضر للمحاصيل الدرنية مثل البطاطس والبطاطا والجزر واللفت0

قام بتحكيم البحث

كلية الزراعة – جامعة المنصورة
كلية الزراعة – جامعة الاسكندرية

أ.د / ماهر محمد ابراهيم عبد العال
أ.د / عبد الله مسعد زين الدين